

Precision Advanced Tuning Fork Electronic Balance

C J - E Series

Operation Manual

IMPORTANT

- To ensure safe and proper use of the balance, please read this manual carefully.
- After reading this manual, store it in a safe place near the balance, so you can review it as needed.

SHINKO DENSHI CO., LTD.

Safety Precautions

Before using the balance, please read this manual carefully.

The nature of dangers and damages that may result in the event of improper operation are indicated under the following categories:



This symbol indicates improper handling that may cause death or severe damage including serious injury. The urgency alerted for danger is high.



This symbol indicates improper handling that may cause death or severe damage including serious injury.



This symbol indicates improper handling that may cause physical injury or damage to property only.

The following symbols give instructions that you need to follow:



Indicates a “prohibited” action.



Indicates a “mandatory” action that must be executed without fail.



Indicates actions that require caution.

To prevent danger to humans and damage to property, be sure to follow the following instructions:

DANGER



Do not disassemble or modify the unit. Doing so could cause accidents such as injury, electrical shock, and fire, or malfunction. For inspection and adjustment of the balance, contact our dealer.



Only use the specified power source. Use of other types of power sources may result in heat generation, fire, or malfunction of the balance.



Only use the dedicated AC adapter. Use of other types of AC adapters may result in heat generation, fire, or malfunction of the balance.



Do not touch the AC adapter with wet hands. Doing so could result in an electrical shock, which may cause an accident with injury or death.

 CAUTION



When the balance is not waterproof and dustproof, do not expose the balance to rain, water, dust, or such other environment. Even though the balance is waterproofed and dustproofed, water and dust may enter the unit if the connector cap to the underfloor weigher hole is detached. Accurate measurement may be rendered impossible in a location where the balance is subjected to rain or water, or in a dusty environment.



Do not lay the AC adapter cable on the surface of a passage. Somebody may trip on the cable, causing the balance to fall, thereby causing injury and/or damage to the balance.



Do not move the balance when a sample is loaded. The loaded sample may fall off the pan and cause an injury and/or damage to the sample and surrounding objects.



Do not place the balance on an unstable base or use the balance in a location where it may be subjected to vibration. The loaded sample may fall off the pan and cause an injury and/or damage to the sample and surrounding objects. Accurate measurement may be rendered impossible.





Avoid applying excess force or impact to the balance.
To prevent breakage or malfunction, place the sample to be measured on the balance carefully.





Do not use volatile solvents for cleaning.
The body may be distorted. To clean the unit of stains, use a piece of dry cloth or cloth soaked in a small quantity of neutral detergent.



 Do not use the balance in the following places:



Location where it may be subject to air from an air-conditioning unit:
 Extreme changes in the ambient temperature may result in inaccurate measurements.



Location where it may be subjected to abrupt changes in ambient temperature or humidity:
 Accurate measurement may be rendered impossible. Use the balance in an ambient temperature range of 0°C to 40°C and with 80% or lower relative humidity.



Location where it is subject to direct sunlight:
 An internal temperature increase in the balance may lead to inaccurate measurement.

Unstable base or location where it may be subjected to vibration:
 In addition to failing to measure the sample accurately, the loaded sample may fall off the pan and cause an injury.

Soft floor:
 When loaded with a sample, the balance may tip or move, preventing accurate measurements from being conducted.

Tilted surface:
 When the balance is tilted, an error may be caused, preventing accurate measurement from being conducted. Place the balance on a level surface.

Respect the following:



Be sure to calibrate the balance after installation or relocation. Measurement values may contain errors. To maintain accurate measurement, be sure to calibrate the balance.



Do not leave the balance overloaded. (When it is overloaded, o-Err is displayed.) To prevent breakage or malfunction, remove the sample placed on the balance immediately.



If the balance is to be unused for an extended period of time, unplug the AC adapter. To conserve power and to prevent deterioration, unplug it.

CAUTION (battery handling)



Never disassemble or modify the batteries. Take care to ensure you insert batteries with the positive and negative poles correctly inserted, and be careful about short circuits. Such mishandling could damage the batteries, or cause the balance to fail or ignite.

Do not put the batteries into a fire. They may explode.



Do not mix old and new batteries, or batteries of different types or manufacturers.



If the balance is not going to be used for a long time, store it with the batteries removed.



Do not use batteries that leak.



Observe the precautions printed on the batteries or rechargeable batteries.



Dispose of batteries in accordance with local regulations.

How to Read this Manual

This manual comprises the following chapters:

Chapter 1	How to Begin	This chapter gives introductory information such as how to assemble and install the balance, and how to turn the power on and off. For your first use of the balance, be sure to read this chapter.
Chapter 2	Basic Operation	This chapter gives basic instructions for how to weigh objects. The procedures for setting the function capabilities used to set various functions are also described.
Chapter 3	Various Measuring Methods	This chapter describes how to use various measuring methods available for the balance, such as parts counting and percentage weighing.
Chapter 4	Adjusting the Balance	The balance needs adjustment depending on where and when it is used. This chapter describes how to calibrate and test the balance.
Chapter 5	Setting the Functions	This chapter describes how to set various functions of the balance, such as setting units and minimum readability.
Chapter 6	Input/Output to/from External Devices	This chapter describes printing to printers and how to input and output to/from RS-232C devices in detail.
Chapter 7	Troubleshooting	This chapter describes how to troubleshoot problems occurring with the balance, including actions required for errors, and trouble remedies.
Appendixes		Required data including the specifications of the balance is described.
Index for Terms		Relevant pages can be searched for through indexed terms.

Notational conventions

In this manual, the following notation is used.

The balance	Refers to a CJ series product.
Measure	Refers to measuring a sample by placing it on the pan. Other expressions such as “weigh” and “measure weight” may also be used.
[Function] key	The names of the operation keys provided on the front of the main unit are expressed in brackets [].
“Func”	The messages shown on the display are expressed in quotation marks “ ”.
Press the key.	Refers to giving a light press of the key.
Press and hold the key.	Refers to holding down the operation key and releasing the finger after an intended display is obtained.

Contents

Safety Precautions	i
How to Read this Manual	viii
Notational conventions	viii
Contents	ix
1-1 Checking Supplied Items	2
1-2 Names and Functions of Component Parts	3
1-3 Workings of Operation Keys	5
1-4 How to See Displayed Signs	6
1-5 Assembling and Installing the Balance	8
Assembling the balance	8
2-1 Powering On/Off the Balance and Checking Operation	12
2-2 Weighing by Placing a Sample in a Container (Tare)	13
2-3 Weighing an Added Sample	14
2-4 Displaying the Sum of the Container and the Sample	15
2-5 Function Setting Basics	16
3-1 Weighing (Weighing Machine)	20
3-2 Counting Parts Count	21
Displaying average sample weight	22
3-3 Measuring Percentage	23
Setting a reference weight by weighing an actual sample	23
Setting a reference weight by entering a value	24
3-4 Obtaining Weight Multiplied by Coefficient	26
3-5 Measuring Specific Gravity	28
Measurement procedures for specific gravity	28
Preparing measurement equipment	28
Measurement	29
Using a liquid medium other than water	31
Gravimeter measurement data output	31
3-6 Weighing an Animal	34
3-7 Adding Multiple Measurements	36
Addition function setting	36

Weighing with addition function.....	37
3-8 Judging “Above” and “Below” (Limit Function).....	38
■ How to judge	38
■ Judgment criteria and limit value setting.....	38
■ Detailed function setting	39
Limit function setting	40
Judging by absolute values.....	41
■ Judging by absolute values using the method of placing actual samples on the balance	41
■ Judging by absolute values using the method of entering values.....	42
Judging by deviation values	43
■ Judging by deviation values using the method of placing actual samples on the balance	43
■ Judging by deviation values using the method of entering values	44
4-1 How to Calibrate.....	48
4-2 Testing the Balance.....	50
5-1 Using Two Expression Units by Switching Them.....	52
5-2 Minimum Readability Setting.....	53
5-3 Saving Container (Tare) Weight	54
5-4 Power Setting	55
Auto Power Off.....	55
Auto Backlight Off	56
5-5 ID No. Setting.....	57
5-6 Improving the Stability of the Balance	59
6-1 Outputting to a Printer	62
Connecting a printer.....	62
Printing span adjustment and span test results.....	62
Printing measurement results	63
6-2 Connecting to External Devices via RS-232C Interface	64
Connector pin numbers and functions	64
Sample connection with a PC	65
Interface specifications	66
6-3 Communication Data and Commands	67
Output data	67

■ Data format.....	68
■ Meanings of data.....	68
Input commands	71
■ Procedure for transmission.....	71
■ Sample input commands.....	71
■ Command form.....	71
■ Command format.....	72
Response.....	75
7-1 Error Messages.....	78
7-2 Troubleshooting.....	80
7-3 Initializing.....	83
7-4 Maintenance.....	84
For heavy dirt.....	84
How to take care of the balance.....	84
Appendix 1 Function Setting List.....	86
Appendix 2 Measurement Mode List.....	90
Appendix 3 Printing in Compliance with ISO/GLP/GMP	91
Appendix 4 Specifications.....	93
■ Basic specifications	93
■ Functional specifications	93
■ Minimum Display by Unit of Measurement.....	95
Appendix 5 Conversion Table Units.....	97
Index for Terms.....	98

How to Begin

This chapter describes the operations required before using the balance, starting from assembling the main unit to turning the power switch on and off.

Before your first use of the balance, be sure to read this chapter.

This chapter includes:

Checking Supplied Items

Names and Functions of Component Parts

Workings of Operation Keys

How to Read Displayed Signs

Assembling and Installing the Balance

1-1 Checking Supplied Items

The following items are contained in the box.

In the unlikely event of problems such as missing or broken items, please contact our dealer from whom the balance was purchased or our Sales Office (See the Appendix at the end of this manual).

Checking Supplied Items



CJ main unit



Pan



Pan base

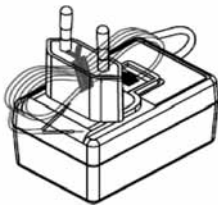

AC adapter

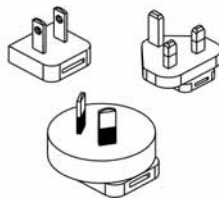

Adapter plug



Operation Manual

Installing the adapter plug

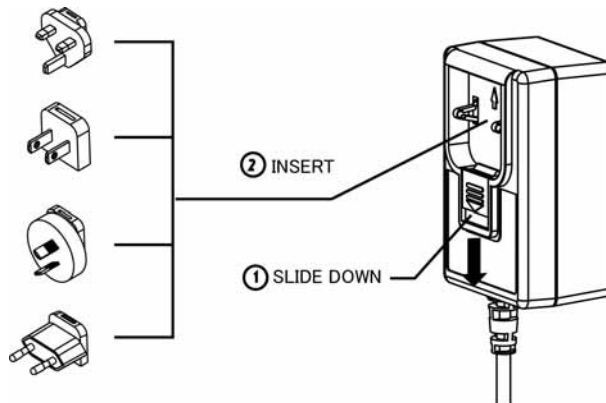

1-2 Names and Functions of Component Parts

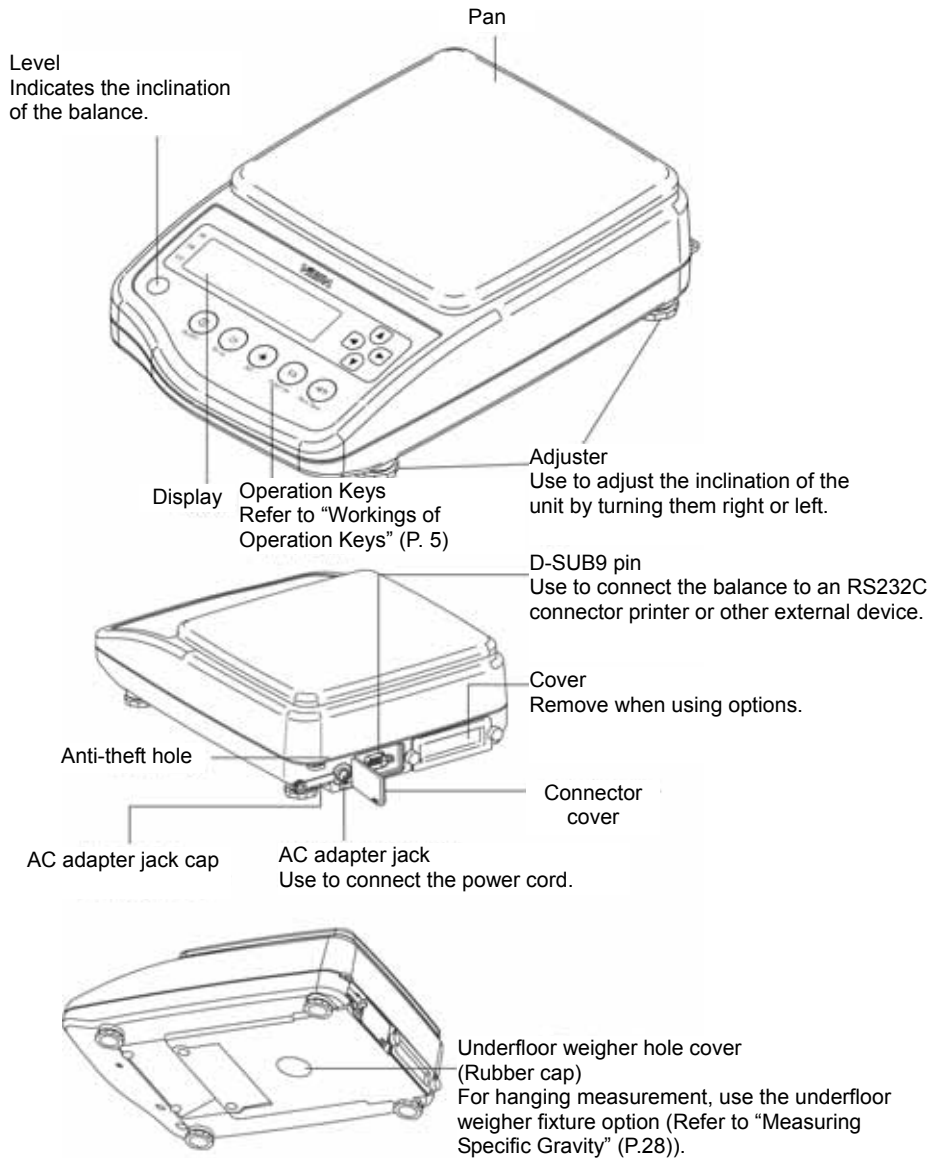

How to Begin

Caution

- When not using the balance, be sure to attach the AC adapter jack cap, connector cover, and the rubber cap and the cover on the bottom to prevent water and dust from entering the unit.
- Note that the waterproofing and dustproofing functions do not work in the following situations:
 - When the cable is connected to the D-SUB9P.
 - When the buzzer option, the full-pack option, and the limit contact output option are used
 - Do not scratch or make a hole in the panel surface (display, operation keys). Water and dust may enter the unit.

1-3 Workings of Operation Keys

The operation keys are provided on the front of the main unit. Use these keys to operate and set the balance.

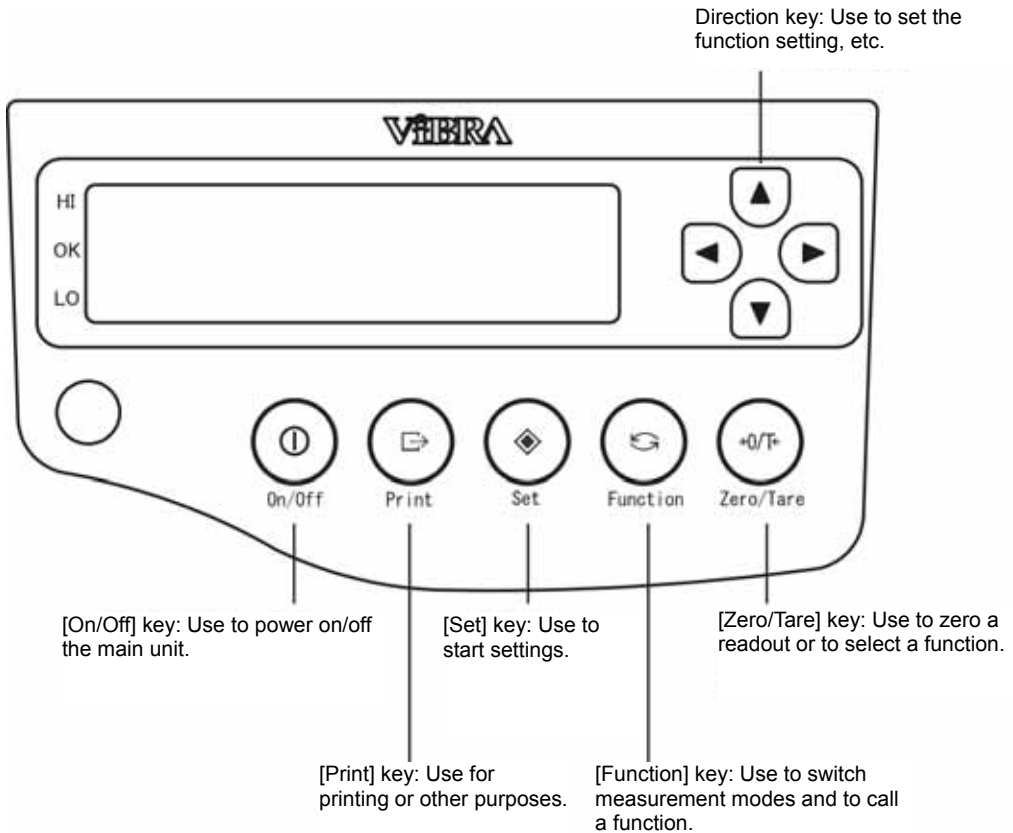

How to press the keys

In some operation keys, executed functions depend on how they are pressed.

For example, the [Set] key saves settings when pressed shortly (short press). When pressed and held, the key inputs settings (press and hold).

In this manual, how keys are pressed is expressed as follows:

Reference

- Press: Give a light press of the key and then release the finger.
- Press and hold: Hold the key down and release the finger after the appropriate display is obtained.
- Continuously press and hold: Hold down the key for three seconds or longer.

Pressing a key can sound the buzzer or change buzzer sound tones (Refer to "Appendix 1: Function Setting List" P. 86).



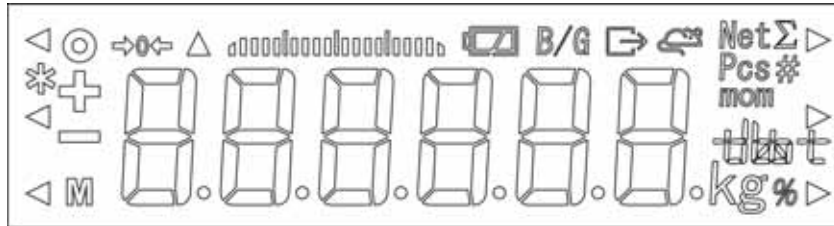

1-4 How to See Displayed Signs

Each of the signs displayed on the front of the main unit has the following meanings:



Displayed sign	Description
⊙	Stable state indicator (Indicates that readout is stable.)
◁	Lights up when the limit function is used.
✱	Indicates that the addition function is enabled when the balance is in addition mode.
—	Minus.
M	Indicates that settings are being saved. Blinks when adjusting the zero-point and when waiting for tare range setting to stabilize.
⇒0⇐	Zero-point.
▂▂▂▂▂▂▂▂▂▂▂▂▂▂▂▂▂▂	Bar graph. Shows gross weight using the rate to the weighing capacity. Displayed in 2-point bar graph.
🔋	Displayed when the balance is powered by batteries. Remaining battery time is indicated in three levels. When this indicator blinks, the batteries are dead.
B/G	Indicates that gross weight is being displayed.
➡	Indicates that data is being output.
🐾	Indicates that the balance is in animal weighing mode.
Net	Lights up when a tare range is set.

1-4 How to See Displayed Signs

Σ	Lights up when sum totals are displayed (shared use together with other readout units) when the addition function is used.
Pcs	Indicates that the balance is in parts counting mode.
#	Indicates that the balance is in unit covering mode.
mom	Indicates the unit momme.
%	Indicates that the balance is in percentage weighing mode.
◁ (Upper) ▷	Indicates that an ID number is being displayed or entered.
	Indicates that actual water temperature (unit: °C) is being entered.
 ▷ (Upper)	Indicates that a specific gravity (unit: none) is being displayed.
 ▷ (Lower)	Indicates that the density of a medium (unit: g/cm ³) is being entered.
◁ (Upper) 	Indicates that midair weight has been saved in gravimeter mode.
	Indicates that a weight value is being held in animal weighing mode.
▷	The response speed in animal weighing mode is indicated with the position to which ▷ points. Fast = fine/Normal = middle/Slow = weak

1-5 Assembling and Installing the Balance

Assembling the balance

Assemble the main unit with the following steps:

1

Attach the pan base.

- ① Align the hole of the pan base to the projection of the main unit.
- ② Fix the pan base by turning the screw.



Place the pan base by aligning it to the projections provided on the main unit and then fix it by turning the screws using a tool such as a coin.

Attach the pan base by aligning it to the projections on the main unit.

Do not overtighten the screws. Fix it by turning the screws using a tool such as a coin.

2

Attach the pan.

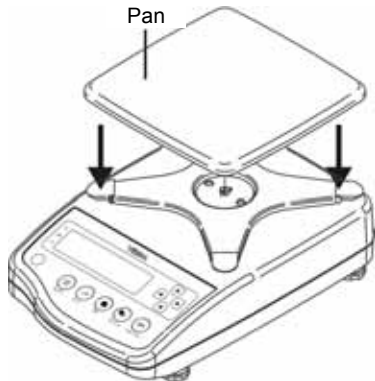

Place the pan on the pan base.

3

Connect the power cord.



Connect the jack provided on the rear of the main unit to a power receptacle using the AC adapter.

Use the balance in a horizontal position.

By using the level provided on the front of the main unit and the adjuster provided on the bottom, the inclination of the main unit can be corrected and checked.

Adjust the inclination of the unit so that the air bubble in the level fits within the circle.



Caution



Adjust the inclination of the unit by turning the four bottom adjusters right and left.

- Start with the adjuster at the shortest position and make adjustments little by little.
- Making adjustments using the other adjuster located on the other side as a pair while observing the level helps to level the balance.
- After the air bubble in the level is within the circle, push the four corners of the balance to check that there is no play.

Basic Operation

This chapter describes how to use basic measuring functions that are used daily.

This chapter includes:

- Powering On/Off the Balance and Checking Operation
- Weighing by Placing a Sample in a Container (Tare)
- Weighing an Added Sample
- Displaying the Sum of the Container and the Sample
- Function Setting Basics

2-1 Powering On/Off the Balance and Checking Operation

Turning the power of the balance on and off

1

Turn the power on.

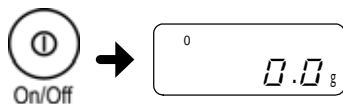

Press the [On/Off] key.

Check that the AC adapter is connected. Zero is shown in the display after all indicators light up.

2

Check operation.

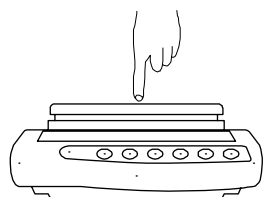

Push the pan using your finger to check that the display readout changes.

Also check that zero is given in the display after the finger is released.

3

Turn the power off.

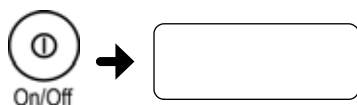

Press the [On/Off] key again.

The display lights out.

- The status of the balance obtained when the power is turned on is the measuring mode that was used before the power was turned off. For example, if the power is turned off in parts counting mode, the balance is started up in parts counting mode when the power is turned on.
- When the balance is stable, "O" is shown in the display.

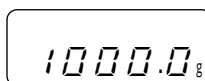

Reference

If the balance is not stable, this "O" lights out. The balance may be under an external influence such as wind and vibration.

Changing settings by referring to "Section 5-6 Improving the Stability of the Balance" (P. 59) can improve stability.

- The bar graph is displayed in the display. This graph shows the current weighted state as a ratio to the weighing capacity. The closer to the right side of the bar, the closer the weight is to the weighing capacity.



2-2 Weighing by Placing a Sample in a Container (Tare)

When measuring weight with the sample in a container (tare), only the sample is weighed by subtracting the weight of the container. This is called “tare.”

1

Place the container on the pan.

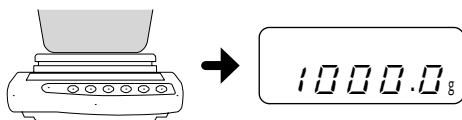

The weight of the container is displayed.

2

Set the tare.

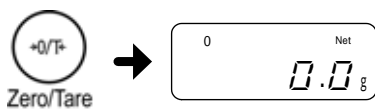

Press the [Zero/Tare] key.

The readout becomes zero, and “→ 0 ←” and “Net” are displayed (tare range setting).

Caution

When “Net” is not displayed even though the [Zero/Tare] key is pressed, zero-point adjustment is being executed, not tare range setting.

3

Place the sample in the container.

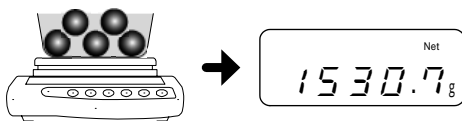

The weight of only the sample is displayed.

Reference

When a tare range is set, the weighable range is reduced by the weight of the tare.

Weighable range = original weighing capacity – pan weight

2-3 Weighing an Added Sample

Place an additional sample. Only the added weight is measured.

1

Place the sample.

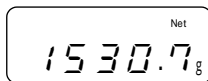
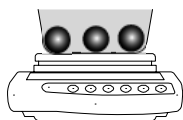

The weight of the placed sample is displayed.

2

Set the tare.

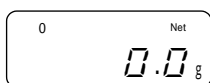

Press the [Zero/Tare] key.

The readout becomes zero (tare range setting).

3

Place the additional sample.

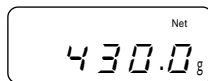
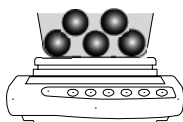

The weight of only the added sample is displayed.

2-4 Displaying the Sum of the Container and the Sample

The sum weight of the sample and the container is displayed (gross weight readout).

Caution A gross weight can only be displayed when the balance functions as a weighing machine. For more information on weighing machine mode, refer to "Weighing" (P. 20).

1 Place the container and then set the tare. Place the container and press the [Zero/Tare] key. The tare range is set and the readout becomes zero.

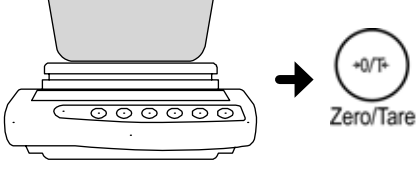

2 Place the sample. The weight of only the sample is displayed (net readout).

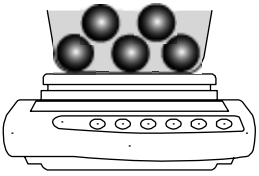

3 Display the sum (gross readout). Press the [Function] key. The sum weight of the container and the sample is displayed (gross readout). When a gross weight is displayed, "B/G" lights up. Pressing the [Function] key toggles the display between gross and net.

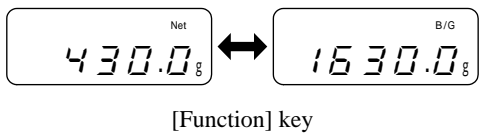
2-5 Function Setting Basics

To set the settings of the balance, use the function keys.

This section describes the basic operations of function setting

Reference

Pressing the [Print] key when a function is being set can cancel the setting and return to measurement mode.

1

Set to the function setting mode.

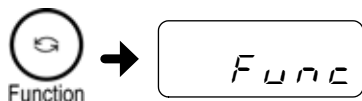

After display changes, release the finger.

Hold down the [Function] key and release the finger after display has changed to "Func". The first function item is displayed.

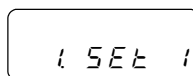

Caution

Keeping the [Function] key held down will switch the balance to another mode. If this happens, press the [Print] key to cancel the setting and redo the setting from the beginning.

2

Select a setting item.

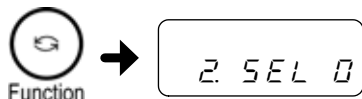

By pressing the [Function] key, select an item to be set.

Example: By pressing the [Function] key once, select "2.5EL" (additional function). The first setting "2.5EL 0" is displayed.

3

Select a setting.

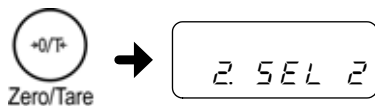

Pressing the [Zero/Tare] key selects a setting.

Pressing the key toggles the settings in turn. After the last setting is displayed, the next setting displayed is the first one.

Example: By pressing the [Zero/Tare] key twice, select "2.5EL 2".

4

Save the setting.



Press the [Set] key to complete the setting.

The display returns to showing the sample's normal weight.

To cancel, press the [Print] key.

Reference

For the items and settings settable by the function capability, refer to “Appendix 1: Function Setting List” (P. 86).

To initialize the function setting, refer to “Section 7-3: Initializing” (P. 83).

Function setting is possible with the direction keys.

After switching to the function setting mode with step 1, use the direction (arrow) keys to change setting items and settings.

To complete the setting, press the [Set] key.

Reference

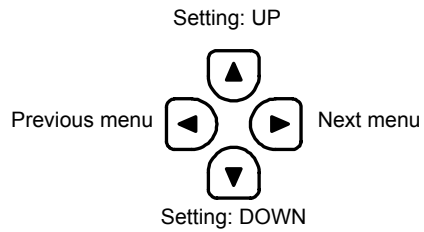

Various Measuring Methods

In addition to weighing, the balance has the following measuring modes: parts counting, percentage weighing, unit converting, gravimeter, and animal weighing.

This chapter includes:

- Weighing (Weighing Machine)
- Counting Parts Count
- Measuring Percentage
- Obtaining Weight Multiplied by Coefficient
- Measuring Specific Gravity
- Weighing an Animal
- Adding Multiple Measurements
- Evaluating “More” and “Less” (Limit Function)

3-1 Weighing (Weighing Machine)

By default, the balance is set to “weighing machine” mode. To return to weighing machine mode from other weighing modes, use the following operation:

1

Set to the function setting mode.
(Refer to “Section 2-5: Function Setting Basics (P. 16).)”)

Press and hold the [Function] key. After “*F u n c*” is displayed, release the finger. “*1 5 E t*” is displayed.

2

Select “Weighing Machine”.

Press the [Zero/Tare] key several times to select “*1 5 E t 1*”.

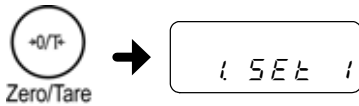

3



Press the [Set] key.
The setting is saved and the display returns to showing the sample's normal weight.

3-2 Counting Parts Count

The balance saves sample weight (unit weight) using the automatic memory update method (simplified SCS method) to count the number of samples.

First, place a set number of samples. Next, place an appropriate number of additional samples, up to three times the set number. Then, the balance will automatically update the average sample weight. Repeating this step allows accurate counting.

1

Set to the function setting mode.
(Refer to “Section 2-5: Function Setting Basics (P. 16).”)

Press and hold the [Function] key. After “*F U N C*” is displayed, release the finger.

2

Select “Parts Counting.”

Press the [Zero/Tare] key several times to select “*1 5 E E 2*.”

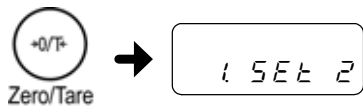

3

Save the weighing mode.

Press the [Set] key.
The “parts counting” mode is set, displaying “Pcs”.

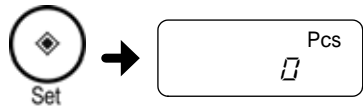

4

Start sampling.

Press and hold the [Function] key. After “*U 5 E E*” is displayed, release the finger.
The “on 10 Pcs” display indicates using ten samples.

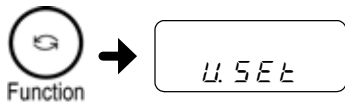

<Press and hold>

Reference
Pressing the [Print] key during sampling can cancel the sampling.

5

Select the number of samples.

Each press of the [Zero/Tare] key can select the sample count between 5, 10, 30, and 100.
If the samples vary considerably in size or are lightweight, set a greater number of samples.

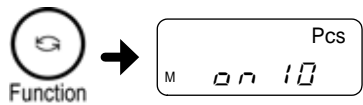

6

Weigh the samples.

Place the set number of samples on the pan and then press the [Function] key.
The displayed sample quantity (Example: “on 10 Pcs”) blinks”.

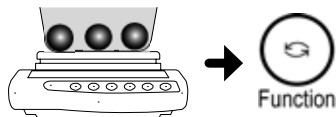

Various Measuring Methods

7

Put additional samples.

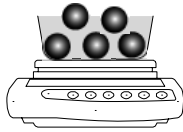

Put additional samples. The number of additional samples is up to three times the set number of samples.

For example, if “10 Pcs” is set, add 30 or less samples.

A blip sound reports you that added samples have been measured.

Repeating this sample addition step can improve the resolution of parts counting.

8

Finish sampling.



Press the [Function] key.

The average sample weight is saved and the balance returns to measurement mode.

9

Place samples to count them.

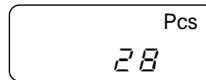

Pressing the [Function] key toggles the display between number of samples, average sample weight, and total weight.

Displaying average sample weight

When weighing in parts counting mode, pressing the [Function] key can display average sample weight.

Pressing the [Function] key toggles the display between number of samples, average sample weight, and total weight.

Reference

- The “*S u b*” display indicates that you added more than three times as many samples as the set number. Decrease the number of additional samples. Starting from a small number of samples, gradually increase the number of samples to increase counting accuracy.
- The “*R d d*” display indicates that the number of added samples is too small. Increase the number of additional samples.
- Even when these indications are displayed, sampling is possible. In this case, however, counting accuracy is low.
- [*L - E r r*] is displayed to indicate that the average sample weight is smaller than the weighable unit weight (Refer to “Appendix 4: Specifications” (P. 93)).

3-3 Measuring Percentage

With respect to the reference sample weight, the weight of a sample is shown in percentage. A reference sample weight can be set by weighing an actual sample (setting a reference weight by weighing an actual sample) or entering a value (setting a reference weight by entering a value).

Setting a reference weight by weighing an actual sample

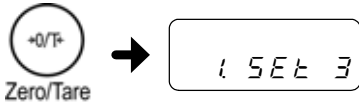
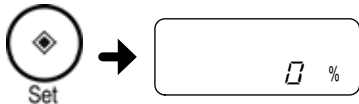
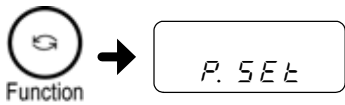
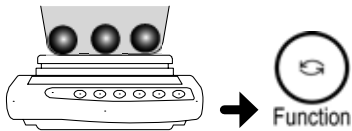
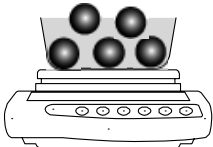
- 1 Set to the function setting mode.
(Refer to "Section 2-5: Function Setting Basics (P. 16).")
Press and hold the [Function] key. After "F u n c" is displayed, release the finger.
- 2 Select "Percentage Weighing".
Press the [Zero/Tare] key several times to select "1 5 E t 3".

- 3 Save the weighing mode.
Press the [Set] key.
The "percent weighing" mode is set, displaying "%".

- 4 Start measuring the reference weight.
Press and hold the [Function] key. After "P. 5 E t" is displayed, release the finger.
The previously-saved reference sample weight blinks.

- 5 Save the reference weight.
Put the reference sample on the balance and then press the [Function] key.
The reference weight is saved.

- 6 Weigh.
The display indicates the percentage of the sample with respect to the reference sample weight.
Pressing the [Function] key toggles the display between percentage weight and total weight.

Setting a reference weight by entering a value

1

Set to the function setting mode.
(Refer to “Section 2-5: Function Setting Basics (P. 16).)”)

Press and hold the [Function] key. After “*F U N C*” is displayed, release the finger.

2

Select “Percentage Weighing”.

Press the [Zero/Tare] key several times to select “*1 5 E E 3*”.

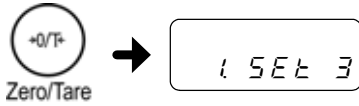

3

Save the weighing mode.

Press the [Set] key.

The “percent weighing” mode is set, displaying “%”.

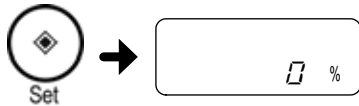

4

Start setting the reference weight.

Press and hold the [Function] key. After “*P 5 E E*” is displayed, release the finger.

The previously-saved reference sample weight blinks.

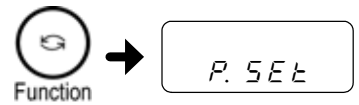

<Press and hold>

5

Enter a reference weight.

Set the reference value with the following steps:

1. Press the [Zero/Tare] key.
The digit furthest to the right side of the value blinks.
2. Select a number by pressing the [Zero/Tare] key.
Pressing the key toggles the number between 0 and 9, and decimal point.
3. Pressing the [Function] key selects the number and the next digit blinks.



Set the reference weight by repeating steps 2 and 3.

Pressing the [Print] key can cancel the setting.

6

Save the value.

Press the [Set] key to save the reference weight.



7

Weigh.

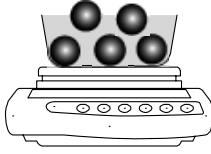

The display indicates the percentage of the sample with respect to the reference sample weight.

Pressing the [Function] key toggles the display between percentage weight and total weight.

The minimum unit is automatically set based on the saved reference weight.

Min. Indication	Range of Reference Weight
1%	Lower weight limit \leq Reference weight $<$ Lower weight limit \times 10
0.1%	Lower weight limit \times 10 \leq Reference weight $<$ Lower weight limit \times 100
0.01%	Lower weight limit \times 100 \leq Reference weight

Reference

- The “L-Err” display indicates that the reference weight is below the lower weight limit, where weighing is impossible. For more information on the weight limit in percentage weighing, refer to “Appendix 4: Specifications” (P. 93).
-

3-4 Obtaining Weight Multiplied by Coefficient

Measured weight is multiplied by a set coefficient, and the result can be displayed.

For example, if “2.35” is set for the coefficient, and the weight of the sample is “2,000 g,” the given readout is “4,700”.

(Example) Sample (2,000 g) × Coefficient (2.35) → Readout (4700)

1 Set to the function setting mode.
(Refer to “Section 2-5: Function Setting Basics (P. 16).) Press and hold the [Function] key. After “*F U N C*” is displayed, release the finger.

2 Select “Unit Converting”. Press the [Zero/Tare] key several times to select “*1 S E T 4*”.

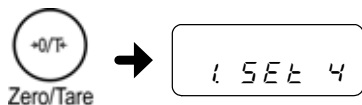

3 Save the weighing mode. Press the [Set] key. The “unit converting” mode is set, displaying “#”.

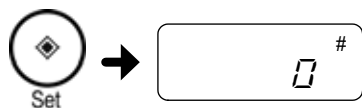

4 Set to the coefficient setting mode. Press and hold the [Function] key. After “*C S E T*” is displayed, release the finger. The previously-saved coefficient is displayed.

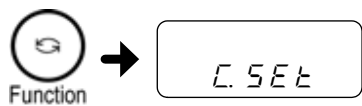

<Press and hold>

5 Enter a coefficient. Set a coefficient with the following steps:



1. Press the [Zero/Tare] key.
The digit furthest to the right side of the value blinks.
2. Select a number by pressing the [Zero/Tare] key.
Pressing the key toggles the number between 0 and 9, and decimal point.
3. Pressing the [Function] key selects the number and the next digit blinks.

Set the coefficient by repeating steps 2 and 3.

Pressing the [Print] key can cancel the setting.

3-4 Obtaining Weight Multiplied by Coefficient

6

Save the coefficient.



Press the [Set] key.

7

Weigh.

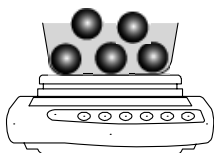

The weight of the sample is multiplied by the coefficient, and the result is displayed.

Reference

The increment of the minimum readability is automatically set to 1, 2, or 5 depending on the entered coefficient.

3-5 Measuring Specific Gravity

The specific gravity of a sample is measured using the underfloor weigher function.

Caution	The “CJ underfloor weigher fixture option” is required (Refer to “Appendix 4 Specifications” (P. 93).
----------------	---

Measurement procedures for specific gravity

Measure specific gravity with the following steps:

1. Preparing measurement equipment
2. Setting water temperature or the specific gravity of the liquid medium
3. Measuring the weight of the sample in the air
4. Correcting errors due to the cage
5. Measuring the weight of the sample in water
6. Displaying a specific gravity value

Preparing measurement equipment

Prepare the following equipment and sample:

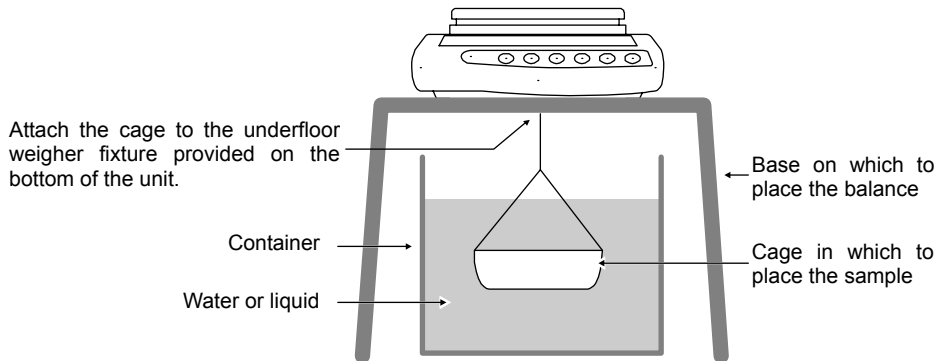

Caution	Using smaller size samples may result in inaccurate measurements. Use as large a sample as possible.
----------------	--

Reference	To measure specific gravity correctly, set the water temperature. Measure the in-container water temperature beforehand.
------------------	--

Measurement

1 Set to the function setting mode.
(Refer to “Section 2-5: Function Setting Basics (P. 16).) Press and hold the [Function] key. After “*F u n c*” is displayed, release the finger.

2 Select “Gravimeter”. Press the [Zero/Tare] key several times to select “*1 5 E t 5*”.

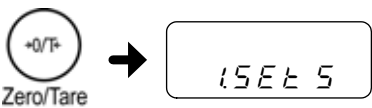

3 Save the weighing mode. Press the [Set] key. The “gravimeter” mode is set, displaying “*d*”.

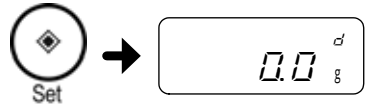

4 Set to the water temperature setting mode. Press and hold the [Zero/Tare] key.

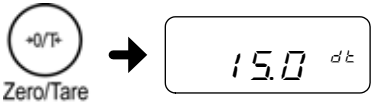

<Press and hold>

5 Set the in-container water temperature. Set the water temperature with the following steps: Set the water temperature starting from a higher-order digit.

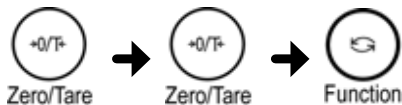

1. Press the [Zero/Tare] key. Zero blinks in the rightmost digit.
2. Select a number by pressing the [Zero/Tare] key. Pressing the key toggles the number between 0 and 9, and decimal point.
3. Pressing the [Function] key shifts the blinking digit to the left, and the next lower-order digit blinks.

Set the water temperature by repeating steps 2 and 3.

Reference

- If using a liquid medium other than water, select the medium by referring to P. 31.
- For a liquid medium other than water, set the density.
- The value set is held even after the power is

Various Measuring Methods

6

Save the water temperature.



Set

7

Hang only the cage to zero the weight readout.

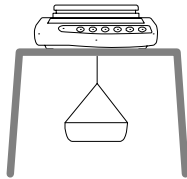

Zero/Tare

8

Measure the weight of the sample.

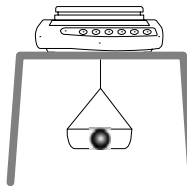

Set

9

Set the liquid container.

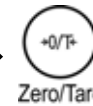
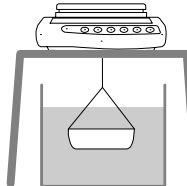

Zero/Tare

10

Place the sample on the cage.

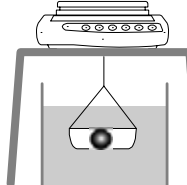

Set

turned off.

- The acceptable range of water temperature is 0 to 99.9°C.
- Pressing the [Print] key can cancel the setting. Press the [Set] key.

Hang only the cage on the underfloor weigher fixture.

Press the [Zero/Tare] key.
The readout becomes zero.

Place the sample on the cage.

After the weight display is stable, press the [Set] key to save the weight of the sample in the air.

When the weight is saved, “◀” is displayed in the lower left of the display.

Measuring a sample by placing it on the pan is also allowed.

Set the container with water under the balance and submerge only the cage (do not place the sample).

Press the [Zero/Tare] key to zero the readout.

This is to remove any residual error due to the cage.

Put the sample on the cage and submerge the entire volume.

After the weight display is stable, press the [Set] key.

The measured specific gravity value is displayed.



Caution

Do not allow the cage to touch the liquid container.

Reference

Press the [Set] key to return to showing the sample's normal weight.

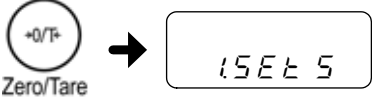
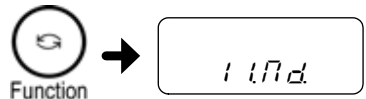
Using a liquid medium other than water

- 1 Set to the function setting mode. (Refer to "Section 2-5: Function Setting Basics (P. 16).")
Press and hold the [Function] key. After "F u n c" is displayed, release the finger.
- 2 Select "Gravimeter".
Press the [Zero/Tare] key several times to select "1 5 E t 5".

- 3 Set to the medium select mode.
Press the [Function] key. "1 1 n d." is displayed.

- 4 Select "Not water".
Select "1" (Not water) by pressing the [Zero/Tare] key and then press the [Set] key.
Now, the specific gravity in a liquid medium other than water can be measured.
Measure specific gravity using the steps described in "Measurement" (P. 29). In step 5, set the density of the used liquid medium instead of water temperature. - The acceptable range of liquid density is 0.0001 to 9.999 g/cm³.

Gravimeter measurement data output

Measured specific gravity data is output to a printer as follows depending on settings:

- Before measurement
Irrespective of the setting made in the function setting "5 1 o. c." (output control), pressing the [Print] key outputs data (irrespective of whether data is stable or unstable).
- While specific gravity is displayed
Output contents and methods can be changed by the function setting "1 2. d. o." (output data select) and "1 3. R. o." (auto output).
- Output format
If [1] (specific gravity, weight, and actual water temperature or density of media) is set in the function setting "1 2. d. o." (output data select), all data is output (See the figures below).
If [0] (specific gravity only) is set in the function setting "1 2. d. o." (output data select), only the first and second line values shown in the figures below are output.
If any statistical calculation is made for the printer, the values in the second line shown in the figures below will be printed being prefixed by a serial number.

Various Measuring Methods

Set language for printing by the function setting “*E 3.P.F.*” (language for printing) (1 = English/2 = Japanese).

Gravimeter measurement data output samples

When water is selected

English	Japanese (Katakana)	
DENSITY SOLID 2.751	コタ化ジ' ヲウ 2.751	Specific gravity of solid
SAMPLE WEIGHT 21.7 g	ジ' ヲウリヨウ 21.7 g	Sample weight
TEMPERATURE NOW 15.0 c	ジ' ツスイオン 15.0 c	Actual water temperature

When other than water is selected

English	Japanese (Katakana)	
DENSITY SOLID 2.414	コタ化ジ' ヲウ 2.414	Specific gravity of solid
SAMPLE WEIGHT 30.3 g	ジ' ヲウリヨウ 30.3 g	Sample weight
DENSITY MED. LIQ 1.325ds	ハ' イタイミツト 1.325ds	Specific gravity of medium

3-6 Weighing an Animal

The balance can accurately weigh animals and other samples that move during measurement. Even if animals and other such moving samples move during measurement, if weight variations fit within a set value range, the measured value is held (fixed) and displayed.

Reference

A weight variation range for value holding can be set with “*1E.Ud.*”.

By changing minimum readability, a stability detection range can be also changed with a combined use of “*1E.Ud.*” (Refer to “Section 5-2: Minimum Readability Setting” (P. 53)).

1

Set to the function setting mode.
(Refer to “Section 2-5: Function Setting Basics (P. 16).)”)

Press and hold the [Function] key. After “*F u n c*” is displayed, release the finger.

2

Select “Animal Weighing”.

Press the [Zero/Tare] key several times to select “*15EtE*”.

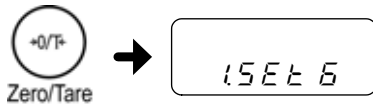

3

Save the weighing mode.

Press the [Set] key.
The “animal weighing” mode is set, displaying “”.

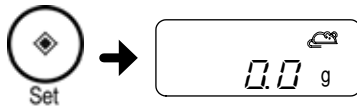

4

Set the response speed according to the animal move.

Set the response speed using the [Set] key.
The response speed is indicated with the position to which the pointer ► located in the right side of the display points.

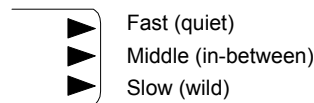

5

Place the sample animal.

When weight variations fit within the set range, the value is held. Holding the readout is reported with “” shown in the display.

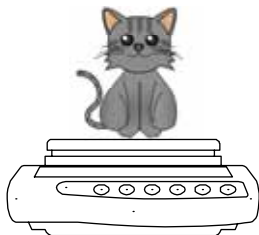

When automatic tare range setting is ON, a tare range is automatically set after the animal is removed and weight variations fit within a set range. When automatic tare range setting is OFF, a held value is displayed until the [Zero/Tare] key is pressed.

Caution

- If the animal moves too much, the value may not be held.
- The measurement unit used in animal weighing is “g” only.
- In animal weighing, because stability detection ranges are wide, errors may occur compared to actual weight.

3-7 Adding Multiple Measurements

Multiple samples are weighed consecutively and the sum is displayed.

The weighing method can be selected from reloading samples (cumulate function) or without replacing samples (net addition function).



The addition function can be used in the following weighing modes: weighing machine, parts counting, percentage weighing, and unit converting.

Addition function setting

1

Set to the function setting mode.
(Refer to "Section 2-5: Function Setting Basics (P. 16).")

Press and hold the [Function] key. After "FUNC" is displayed, release the finger.

2

Select Addition Function.



Press the [Function] key several times to select "2SEL".

Press the [Zero/Tare] key to select "2SEL 1".



When using both the cumulate and limit functions together, select "2SEL 3".

For more information on the limit function, refer to "Section 3-8: Judging "Above" and "Below"" (P. 38).

3

Select cumulate or net addition.

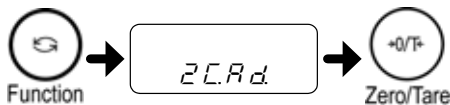

Press the [Function] key. After "2CAL" is displayed, press the [Zero/Tare] key to set the value.

1: Cumulate function

2: Net addition function

4

Finish setting.



Press the [Set] key.

The addition function is set.

Weighing with addition function

1

Place the first sample.

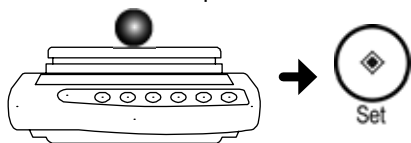

After an asterisk (*) is displayed, press the [Set] key.

The measured value is saved and a sigma [Σ] sign is displayed for several seconds.

2

Place another sample (cumulative).

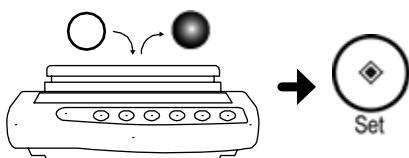

After an asterisk (*) is displayed, press the [Set] key.

The measured value is saved, and a [Σ] sign and the cumulative weight are displayed for several seconds.

Place additional samples (net addition).

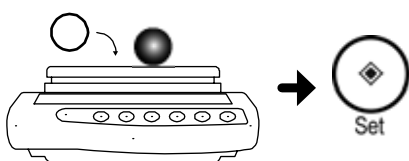

Repeat this operation to weigh all the samples to be summed.

Caution

After unloading the previous sample, check that the display indicates "0", and place the next sample.

Reference

Cumulating weight is also possible as follows: Press the [Zero/Tare] key without unloading the balance and then place next samples.

Press the [Function] key twice.

A [Σ] sign and the cumulative weight are displayed.

3

Display the cumulative weight.



- Pressing the [Zero/Tare] key when a cumulative weight is displayed clears the cumulative weight.
- You can add samples when an asterisk (*) is displayed.
- When "H E r r" is displayed by pressing the [Set] key, it indicates that you put additional samples on twice or that you unloaded some samples.
- The function setting "H E R" can be used for turning ON/OFF the function to wait for stabilization upon additions (Refer to "Appendix 1: Function Setting List" (P. 86)).

Reference

3-8 Judging “Above” and “Below” (Limit Function)

By setting values in the balance, you can judge whether measured values fit within set ranges.

Reference

The limit function can be used in the following weighing modes: weighing machine, parts counting, percentage weighing, and unit converting.

■ How to judge

Set lower and upper limits. The judgment result is indicated by “◀” telling you that the measured value is below (below lower limit), appropriate, or above (above upper limit).

	When one point (lower limit) is set	When two points (lower and upper limits) are set
HI	N/A	Upper limit < Weight
OK	Lower limit ≤ Weight	Lower limit ≤ Weight
LO	Weight < Lower limit	Weight < Lower limit

Reference

For the case of one point setting, the point to be set is for only the lower limit that judges “appropriate” and “below.”

Judgment results can be also displayed in graph form.

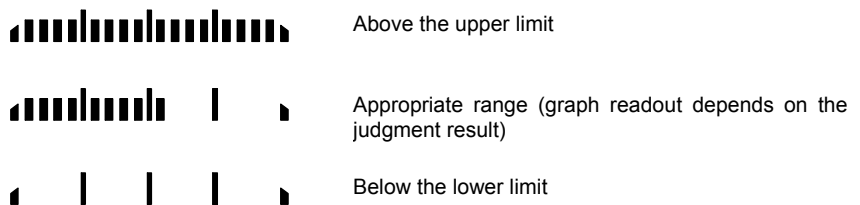

Set the function setting “*RLU*” to “2”(2-point bar graph)(Refer to “Appendix 1: Function Setting List” (P. 86)).

Bar graph display is possible only for “two point setting.”

■ Judgment criteria and limit value setting

A limit value can be judged with any of the following criteria:

- Absolute value: Values (limit values) including upper and lower values are set. Based on these values, measurements are judged.
- Deviation value: A reference value is set. Measurements are judged by specifying an upper limit or a lower limit range with respect to this reference weight.

3-8 Judging “Above” and “Below” (Limit Function)

A limit value can be entered in the following two ways:

- Putting actual samples on the balance: By weighing a sample on the balance, save the weight.
- Entering values: Set a value using the keys.

■ Detailed function setting

In the function setting function, the limit function can be set in detail.

When the function setting “*2.5EL*” is “*2*” or “*3*”, pressing the [Function] key can set the following: Set these items as required.

Condition	<i>2 1L0.</i>	1: Always judge. 2: Judge only when the balance is stable.
Range to Cover	<i>2 2L 1.</i>	0: Detect when the limit is exceeded by more than five divisions. 1: Detect both when the limit is exceeded and when it is not reached.
Point Scale	<i>2 3P 1.</i>	1: 1-point scale (OK and LO are judged.) 2: Upper and lower limits are set (HI, OK and LO are judged).
Judge by	<i>2 4LP.</i>	1: Judge by absolute values. 2: Judge by deviation values.
Buzzer for LO	<i>2 5b. 1</i>	0: The buzzer is not beeped for rank LO. 1: The buzzer is beeped for rank LO.
Buzzer for OK	<i>2 6b. 2</i>	0: The buzzer is not beeped for rank OK. 1: The buzzer is beeped for rank OK.
Buzzer for HI	<i>2 7b. 3</i>	0: The buzzer is not beeped for rank HI. 1: The buzzer is beeped for rank HI.

Caution	<ul style="list-style-type: none"> - Separate limit values can be saved for each weighing mode. However, limit values of both absolute and deviation values cannot be saved in the same weighing mode. - Limit values can be set only in measurement mode display (Cannot be set in other mode display such as when a cumulative value is displayed). - Before setting limit values, as required, adjust the zero-point or set a tare range. - If the limit value entries are not lined up in the order of magnitude, three “◀” will be lit. Enter the values again.
----------------	--

Limit function setting

First, set the limit function. Then, set limit values.

1

Set to the function setting mode.
(Refer to "Section 2-5: Function Setting Basics (P. 16).")

Press and hold the [Function] key. After "F u n c" is displayed, release the finger.

2

Select Limit Function.



Press the [Function] key several times to select "2.5 E L".

Press the [Zero/Tare] key to select "2.5 E L 2". When using both the cumulate and limit functions together, select "2.5 E L 3".

3

Set the judgment condition.

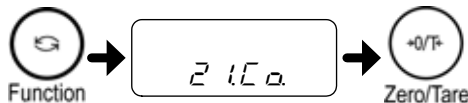

Press the [Function] key several times to select "2 I C a".

Press the [Zero/Tare] key to select the judgment condition.

1: Always judge (even when the balance is unstable).

2: Judge only when the balance is stable.

4

Set the judgment range to cover.

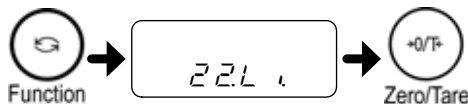

Press the [Function] key several times to select "2 2 L i".

Press the [Zero/Tare] key to select the judgment range to cover.

0: Detect when the limit is exceeded by more than five divisions.

1: Detect both when the limit is exceeded and when it is not reached.

5

Set the point scale to be set.

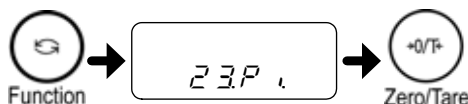

Press the [Function] key several times to select "2 3 P i".

Press the [Zero/Tare] key to select the point scale to be set.

1: 1-point scale (OK and LO are judged.)

2: Upper and lower limits are set (HI, OK and LO are judged).

6

Set the judgment method.

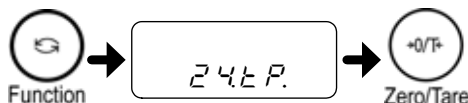

Press the [Function] key several times to select "2 4 E P".

Press the [Zero/Tare] key to select the judgment method.

1: Judge by absolute values.

2: Judge by deviation values.

7

Save the setting.

Press the [Set] key.



Then, set the values for judgment (limit values) to perform measurement.

Judging by absolute values

The function setting for absolute value judgment is “*24. P. 1*”.

■ Judging by absolute values using the method of placing actual samples on the balance

Set upper and lower limits by weighing samples.

Check that the limit function is set for judging by absolute values (Refer to the previous section “Limit function setting”).

1

Set to the mode of using actual samples.

Press and hold the [Set] key. After “*L.S E t*” is displayed, release the finger.

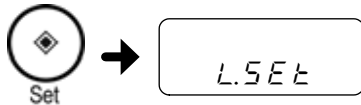

<Press and hold>

2

Weigh the lower limit sample.

Place the sample serving as the lower limit and then press the [Function] key.

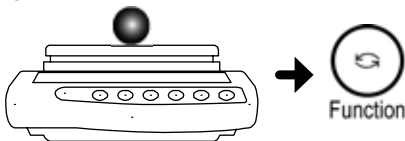

For the case of one point setting, this operation completes the setting saving. Go to step 4.
For the case of two point setting, “*H.S E t*” is displayed.

3

Weigh the upper limit sample.

Place the sample serving as the upper limit weight on the pan and then press the [Function] key.

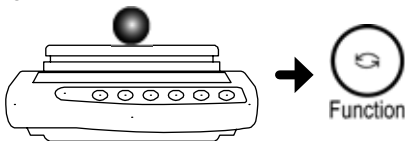

The judgment value is saved and then the balance goes back to normal display.

4

Weigh.

Place a judgment target sample on the pan.

The OK, LO, or HI result judged from the upper and lower limit values is displayed with the “◀” indication.

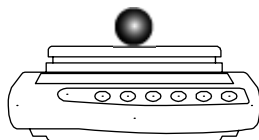

Various Measuring Methods

■ Judging by absolute values using the method of entering values

Set upper and lower limits by entering values using the keys.

Check that the limit function is set for judging by absolute values (Refer to the previous section “Limit function setting”).

1

Set to the mode of entering values.

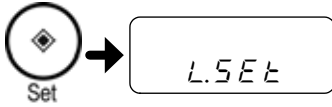

Press and hold the [Set] key. After “L.S E t” is displayed, release the finger.

2

<Press and hold>

Enter the lower limit value.

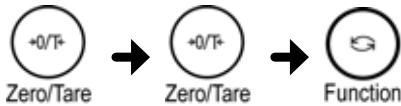

Enter the lower limit value with the following steps:

1. Press the [Zero/Tare] key.
Zero blinks in the right end.
2. Select a number by pressing the [Zero/Tare] key.
Pressing the key toggles the number between 0 and 9, and decimal point.
3. Pressing the [Function] key shifts the blinking digit to the left, and the next lower-order digit blinks.
4. Press the [Set] key to save the value.

For the case of one point setting, this operation completes the setting saving. Go to step 4.

For the case of two point setting, “H.S E t” is displayed.

3

Enter the upper limit value.

Enter the upper limit value by using the same operation as with step 2.

The judgment value is saved and then the balance goes back to normal display.

4

Weigh.

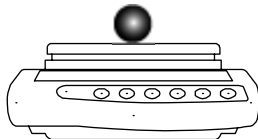

Place a judgment target sample on the pan.

The OK, LO, or HI result judged from the upper and lower limit values is displayed with the “◀” indication.

Judging by deviation values

The function setting for deviation value judgment is “24tP.2”.

■ Judging by deviation values using the method of placing actual samples on the balance

Set a reference, upper limit, and lower limit values by weighing samples.

Check that the limit function is set for judging by deviation values (refer to the previous section “Limit function setting”).

- 1 Set to the mode of using actual samples. Press and hold the [Set] key. After “r.5Et” is displayed, release the finger.

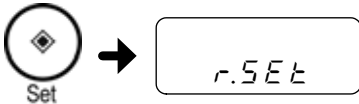

- 2 Weigh the reference weight sample. Place the sample serving as the reference value and then press the [Function] key.

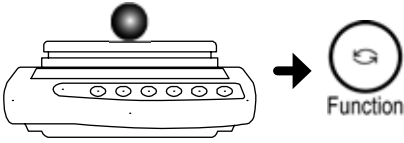
<Press and hold>

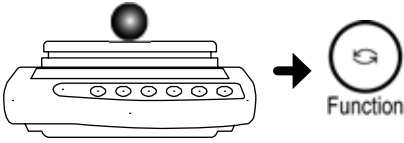
- 3 Weigh the lower limit sample. Place the sample serving as the lower limit and then press the [Function] key. For the case of one point setting, this operation completes the setting saving. Go to step 5. For the case of two point setting, “H5Et” is displayed.

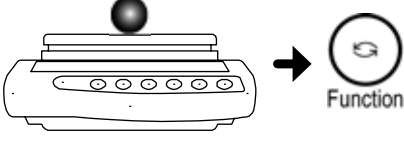
- 4 Weigh the upper limit sample. Place the sample serving as the upper limit weight on the pan and then press the [Function] key. The judgment value is saved and then the balance goes back to normal display.

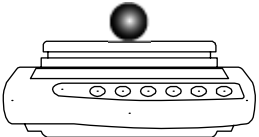
- 5 Weigh. Place a judgment target sample on the pan. The OK, LO, or HI result judged from the upper and lower limit values is displayed with the “◀” indication.



Various Measuring Methods

■ Judging by deviation values using the method of entering values

Set a reference, upper limit, and lower limit values by entering values using the keys.

Check that the limit function is set for judging by deviation values (Refer to the previous section “Limit function setting”).

For making judgments by deviation values using the method of entering values, the lower and upper limit values to be entered are their differences with respect to the reference weight.

For example, when a judgment is made with an upper limit of 1,050 g and a lower limit of 900 g, enter a reference weight of 1000 g, an upper limit of 50 g, and a lower limit of -100 g.

1

Set to the mode of entering values.

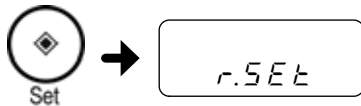

Press and hold the [Set] key. After “r.SET” is displayed, release the finger.

<Press and hold>

2

Enter the reference value.



Enter the reference value with the following steps:

1. Press the [Zero/Tare] key.
Zero blinks in the right end.
2. Select a number by pressing the [Zero/Tare] key.
Pressing the key toggles the number between 0 and 9, and decimal point.
3. Pressing the [Function] key shifts the blinking digit to the left, and the next lower-order digit blinks.
4. Press the [Set] key to save the value.

3

Enter the lower limit value.

Enter the lower limit value by using the same operation as with step 2.

For the case of one point setting, this operation completes the setting saving. Go to step 5.

For the case of two point setting, “LSET” is displayed.

4

Enter the upper limit value.

Enter the upper limit value by using the same operation as with step 2.

The judgment value is saved and then the balance goes back to normal display.

3-8 Judging “Above” and “Below” (Limit Function)

5

Weigh.

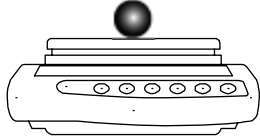

Place a judgment target sample on the pan.

The OK, LO, or HI result judged from the upper and lower limit values is displayed with the “◀” indication.

Adjusting the Scale

Calibrate the balance using weights.

This chapter includes:

How to Calibrate

Testing the Balance

4-1 How to Calibrate

To calibrate a balance is called span adjustment. Be sure to perform span adjustment for highly accurate measurements.

An electronic balance is influenced by the acceleration of gravity. For this reason, you should calibrate your balance every time you relocate it. You should also calibrate it after a long time of use or when it does not indicate correct values.

Caution To adjust the span, wait at least 15 minutes after the balance is powered on.

Reference Use a weight for calibration that weighs 50% of the weighing capacity or heavier. To calibrate more accurately, use a weight that is equivalent to the weighing capacity.
Please contact us if you wish inquire about or place an order for calibration weights.

- 1 Set to the function setting mode.
(Refer to "Section 2-5: Function Setting Basics (P. 16).")

Press and hold the [Function] key. After "FUNC" is displayed, release the finger.
- 2 Set to the span adjustment mode.



Press the [Function] key several times to select "CAL".
Press the [Zero/Tare] key several times to select "CAL 3".
- 3 Save the setting.



Set

Press the [Set] key.
The balance goes back to normal display.
- 4 Start span adjustment.

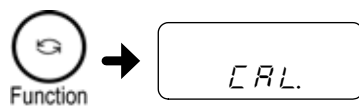

Keep holding down the [Function] key until "CAL" is displayed.
- 5 Start zero-point adjustment.



Releasing the finger changes the display to the blinking of "0.00", starting zero-point adjustment.

6

Place the weight on the pan.



After zero-point adjustment finishes and the display changes to “o n F.5”, place the weight on the pan.

Adjustment starts.

7

Span adjustment starts.

After display changes to the blinking of “o n F.5”, span adjustment starts.

8

Span adjustment finishes.

After span adjustment finishes, “E n d” is displayed.

The balance goes back to normal display.

Reference

-
- Pressing any other key than the [Function] key cancels adjustment.
 - The “l - E r r” display indicates that you used a weight weighing less than 50% of the weighing capacity.
 - The “2 - E r r” display indicates that an error over 1.0% was detected, or the balance failed. For more information, refer to “Section 7-2: Troubleshooting” (P. 80).
-

4-2 Testing the Balance

The amount of offset with respect to the reference weight can be checked. This is called “span test”.

Performing a span test will not calibrate the balance.

Reference

Use a weight for calibration that weighs 50% of the weighing capacity or heavier. To calibrate more accurately, use a weight that is equivalent to the weighing capacity.

Please contact us if you wish inquire about or place an order for calibration weights.

1

Set to the function setting mode.
(Refer to “Section 2-5: Function Setting Basics (P. 16).)”)

Press and hold the [Function] key. After “*F U N C*” is displayed, release the finger.

2

Set to the span test mode.

Press the [Function] key several times to select “*7* *E R*”.



Press the [Zero/Tare] key several times to select “*7 E R 4*”.

3

Save the setting.

Press the [Set] key.
The balance goes back to normal display.



4

Start span test.

Keep holding down the [Function] key until “*t E S t*” is displayed.
After zero-point testing (“*o n 0*” blinks), the display changes to “*o n F.S.*”.

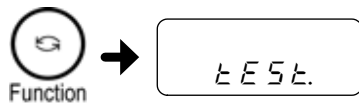

<Press and hold>

5

Place the weight on the pan.

After “*o n F.S.*” is displayed, place the weight on the pan.
The test starts.

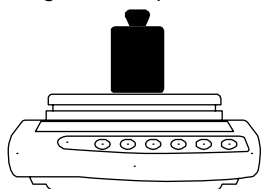

6

The error is displayed.

The display first indicates “*d I F F*” and then the weight error of the balance.
A weight error is as follows:
Weight error = True value – Current weight
When a weight error is more than “0”, the displayed weight is less than the actual weight.
Press any key to return to normal display.

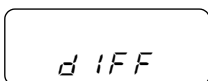

Function Setting

Set the functions of the balance.

This chapter includes:

Using Two Expression Units by Switching Them

Minimum Readability Setting

Saving Container (Tare) Weight

Power Setting

ID No. Setting

Improving the Stability of the Balance

5-1 Using Two Expression Units by Switching Them

You can set two units (unit A and unit B) and switch between the units.

Reference

Unit B can be used only in weighing machine mode. Unit A can be used in all measurement modes.

For more information on selectable units, refer to “Appendix 1: Function Setting List” (P. 86).

1

Set to the function setting mode.
(Refer to “Section 2-5: Function Setting Basics (P. 16).)”)

Press and hold the [Function] key. After “*F U N C*” is displayed, release the finger.

2

Set unit A.



Press the [Function] key several times to select “*b 1.u.R*”.

Select unit from the following numbers by pressing the [Zero/Tare] key.

1: *g/2*: kg/4: ct (carat), etc.

When setting only the unit A, press the [Set] key in this step to save the setting.

3

Set unit B.



Press the [Function] key several times to select “*b 3.u.b*”.

Select unit from the following numbers by pressing the [Zero/Tare] key.

1: *g/2*: kg/4: ct (carat), etc.

Reference

Unit B can be used only in weighing machine mode.

4

Save the setting.



Press the [Set] key.

The balance goes back to normal display.

5

How to switch between unit A and unit B





Pressing the [Function] key during measurement switches between unit A and unit B.

5-2 Minimum Readability Setting

Use this function to set the minimum readability. The larger the minimum readability becomes, the less the balance is affected by external influences. In addition, it takes less time for the balance reading to become stable.

Each unit has different minimum readability.

- 1 Set to the function setting mode. (Refer to "Section 2-5: Function Setting Basics (P. 16).")
Press and hold the [Function] key. After "F u n c" is displayed, release the finger.
- 2 Select the minimum readability.
Press the [Function] key several times to select "b 2.d.R.". Select from 1 through 5 by pressing the [Zero/Tare] key.

- 3 Save the setting.
Press the [Set] key.
The balance goes back to normal display.

Reference

To set the minimum readability of unit B, select "b 4.d.b" in step 2.

You can also set the same unit for unit A and unit B, and set different minimum readability, so that unit A and unit B can be used to switch the minimum readability.

■ Minimum readability example

Setting value	CJ-220E~820E				CJ-2200E~8200E				CJ-15KE			
	g	kg	ct	mom	g	kg	ct	mom	g	kg	ct	mom
1	0.01	0.00001	0.05	0.005	0.1	0.0001	0.5	0.05	1	0.001	5	0.5
2	0.02	0.00002	0.1	0.01	0.2	0.0002	1	0.1	2	0.002	10	1
3	0.05	0.00005	0.2	0.02	0.5	0.0005	2	0.2	5	0.005	10	2
4	0.1	0.0001	0.5	0.05	1	0.001	5	0.5	10	0.01	10	5
5	0.2	0.0002	1	0.1	2	0.002	10	1	10	0.02	10	10

5-3 Saving Container (Tare) Weight

Use this function to set a tare range when the balance is powered on using the latest saved tare weight. Use this function when you turn the balance on or off with a sample and tare put on the pan.

Caution Leaving the balance loaded with a substance and tare for a long period may result in a larger error in weighing. You should set the tare range regularly.

- 1 Set to the function setting mode.
(Refer to “Section 2-5: Function Setting Basics (P. 16).) Press and hold the [Function] key. After “*F U N C*” is displayed, release the finger.
- 2 Set the tare saving. Press the [Function] key several times to select “*T A R E*”. Select “1” by pressing the [Zero/Tare] key.

- 3 Save the setting. Press the [Set] key. The balance goes back to normal display.

- 4 Save the tare weight. Place the container (tare) to be saved for weight and then measure the tare. The saved tare weight is updated every time a tare range is set.

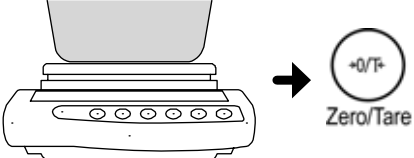



5-4 Power Setting

Auto Power Off

This function, which is only available when the balance is operated by batteries, turns off the balance automatically if left untouched for about five minutes.

- 1 Set to the function setting mode. (Refer to “Section 2-5: Function Setting Basics (P. 16).”) Press and hold the [Function] key. After “*F u n c*” is displayed, release the finger.
- 2 Set the auto power off. Press the [Function] key several times to select “*Q P P*”. Select “1” by pressing the [Zero/Tare] key.

- 3 Save the setting. Press the [Set] key. The balance goes back to normal display.



The auto power off function does not work under the following conditions:

- Function settings, time or date, or the interval function are set.
- An object is placed on the pan, and display is not stable.
- The balance is operated on the AC adapter.

Reference

To use the balance again after it is powered off, start from turning the power on.

Function Setting

Auto Backlight Off

This function automatically turns off the backlight if the balance is left untouched in measurement mode for about three minutes.

1

Set to the function setting mode.
(Refer to “Section 2-5: Function Setting Basics (P. 16).)”)

Press and hold the [Function] key. After “*F u n c*” is displayed, release the finger.

2

Set the auto backlight off.

Press the [Function] key several times to select “*R.A.b.*”.



Select “1” by pressing the [Zero/Tare] key.

3

Save the setting.

Press the [Set] key.

The balance goes back to normal display.



The auto backlight off function does not work under the following conditions:

Reference

- Function settings are set.
- An object is placed on the pan, and display is not stable.

Placing an object on the pan or pressing any key turns the backlight on again automatically.

5-5 ID No. Setting

Results of successfully completed span adjustments and span tests can be printed by ISO/GLP/GMP compliant devices. Set the ID numbers printed together at this printing.

In situations such as when the same model is used, you can assign numbers that allow you to control them easily.

When an ID number is set, the “◀” and “▶” indicators located in the upper left of the display light up.

You can use up to six digits in an ID number. The characters that you can use are as follows:
Space (blank), 0 to 9, A to F, -

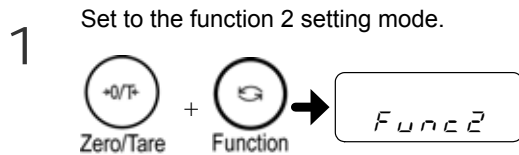

Press the [Function] key while pressing the [Zero/Tare] key. Release the fingers when “Func 2” is displayed.

The function 2 setting mode is set, displaying “Func 2”.

Select “1” by pressing the [Zero/Tare] key.

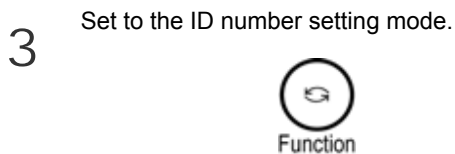
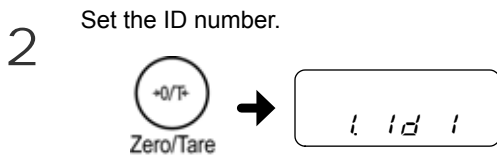

Press the [Function] key.

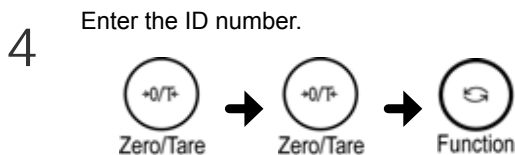

Enter the ID number with the following steps:

1. Press the [Zero/Tare] key.
The leftmost digit blinks.
2. Select a character by pressing the [Zero/Tare] key.
Pressing the key toggles between space, 0 to 9, A to F, and – (minus).
3. Pressing the [Function] key blinks the next digit.

Set the ID number by repeating steps 2 and 3.

Function Setting

5

Save the ID number.



Press the [Set] key.

Display changes to “ $\bar{2}$. 0 0 . 0”.

Pressing the [Set] key again returns the balance to normal display.

5-6 Improving the Stability of the Balance

When the balance is stable, “O” is lit in the upper left of the display.

When displayed values flicker and stabilized display blinks, it indicates that the balance is influenced by wind or vibration. In these situations, making a setting change can improve stability.

As greater values are set in the function setting of “stability judgment (4.5.d.)”, “response speed (5.r.E.)”, and “minimum readability setting (b2.d.R, b4.d.b)”, stability will be improved more.

Relationship between each function setting and wind/vibration influences

Wind/vibration influences	Stability judgment	Response speed	Minimum readability setting
Small Big	1	1	1
	2	2	2
	3	3	3
	4	4	4
	5	5	5

Reference

In each of the functions, if wind and vibration influences are small, select 1 or 2. Set 3 to 5 for great influences.

1

Set to the function setting mode.
(Refer to “Section 2-5: Function Setting Basics (P. 16).)”)

Press and hold the [Function] key. After “F u n c” is displayed, release the finger.

2

Select each function.



Press the [Function] key several times to select the functions (See the above table).

- 4.5.d = Stability judgment
- 5.r.E = Response speed
- b2.d.R = Minimum readability setting (A)
- b4.d.b = Minimum readability setting (B)

3

Select a setting.



Press the [Zero/Tare] key to select the setting values of each function (see the above table).

Function Setting

4

Save the setting.



Press the [Set] key.

The balance goes back to normal display.

Input/Output to/from External Devices

Balance data can be output to a printer and be input and output to/from external devices via the RS-232C interface.

This chapter includes:

Outputting to a Printer

Connecting to External Devices via RS-232C Interface

Communication Data and Commands

6-1 Outputting to a Printer

By connecting a printer to the balance, span adjustment and span test results and measurement results can be printed in ISO/GLP/GMP compliant form.

Reference

For printing examples, refer to “Appendix 3: Printing in Compliance with ISO/GLP/GMP” (P. 91).

Connecting a printer

By using the D-SUB9P cable, connect the RS-232C connector of the balance to a printer.

The printers that can be connected to the balance are CSP-160 (SHINKO DENSHI).



For the printer, the following setting is required. Set the following by referring to the operation manual of the printer.

- Set the printing function (printing control) to “balance control.”
- Make the baud rate and other communication settings compatible with the settings made in the balance.

Caution

The date and time data set in the printer is also printed. Before printing, set the date and time in the printer.

Printing span adjustment and span test results

- 1 Set to the function setting mode.
(Refer to “Section 2-5: Function Setting Basics (P. 16).) Press and hold the [Function] key. After “*F u n c*” is displayed, release the finger.
- 2  Press the [Function] key several times to select “*E. G L P*”.
Select “1” by pressing the [Zero/Tare] key.
- 3  Press the [Function] key several times to select “*E. I. C. O*”.
Select “1” by pressing the [Zero/Tare] key.
- 4 Save the setting. Press the [Set] key.
The balance goes back to normal display.

5

Perform span adjustment or span test.

After span adjustment or test is successfully completed, the printer executes printing.

While the data is being printed, the balance may seem to not be moving, but wait until printing is completed.

No printing is executed if span adjustment or test is not successfully completed.

Caution

Do not press any keys on the printer during printing.

Printing measurement results

1

Set to the function setting mode.
(Refer to "Section 2-5: Function Setting Basics (P. 16).")

Press and hold the [Function] key. After "Func" is displayed, release the finger.

2



Press the [Function] key several times to select "E.GLP".

Select "1" by pressing the [Zero/Tare] key.

3



Press the [Function] key several times to select "E2.0d."

Select "1" by pressing the [Zero/Tare] key.

4

Save the setting.



Press the [Set] key.

The balance goes back to normal display.

5

Print.

Pressing and holding the [Print] key prints the header.

- Pressing the [Print] key at any time during measurements prints result data.
- After the measurement is completed, press and hold the [Print] key. The footer is printed.

Caution

Do not press any keys on the printer during printing.

6-2 Connecting to External Devices via RS-232C Interface

The balance inputs and outputs from and to external devices such as a PC via the RS-232C interface.

The RS-232C interface equipped on the balance is a D-SUB9P type. The connection with external devices is established with the following specifications:

Caution Disconnect the AC adapter of the balance before connecting external devices.

Connector pin numbers and functions

The RS-232C connector equipped on the balance has the following pin alignment:

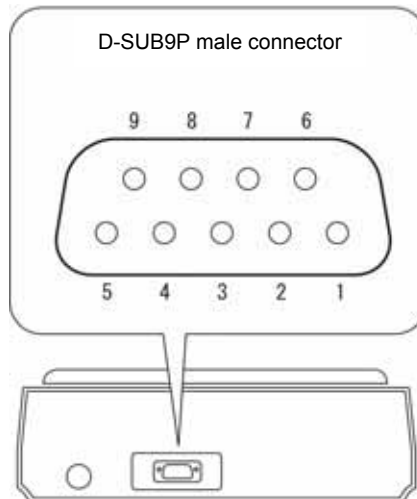

Pin number	Signal name	Input/Output	Function & Remarks
1	-	-	-
2	RXD	Input	Receiving data
3	TXD	Output	Transmitting data
4	DTR	Output	HIGH (When the balance is powered ON)
5	GND	-	Signal ground
6	-	-	-
7	-	-	-
8	-	-	-
9	EXT.TARE	Input	External tare range setting

Reference

You can set a tare range or adjust the zero-point from an external device by connecting a contact or a transistor switch between the pin for externally setting a tare range (Pin 9) to the pin for signal ground (Pin 5). In this case, allow at least 400 ms for connection (ON) time (Maximum voltage when the balance is turned OFF: 15 V, sink current when it is turned ON: 20 mA.)

Sample connection with a PC

Use the following examples as a guide to connect the balance to external devices using the cable.

- Sample connection with a PC/AT compatible machine

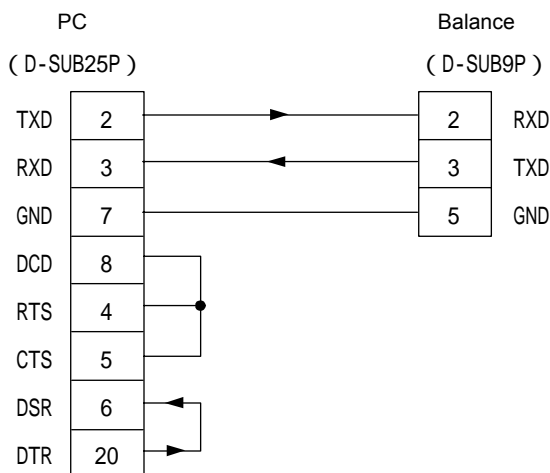
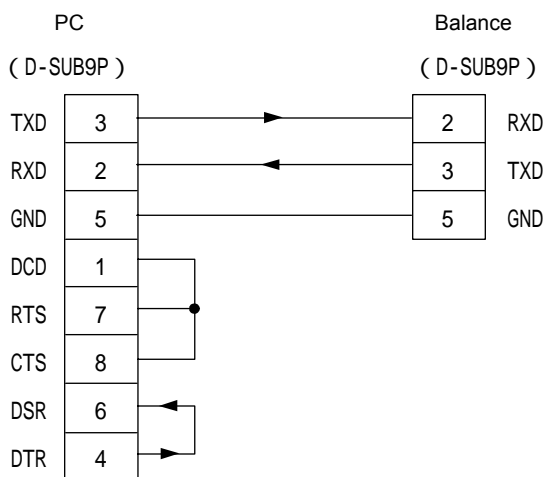

Interface specifications

Transmission system	Serial transmission, Start-stop synchronization
Transmission rate	1200/2400/4800/9600/19200 bps
Transmission codes	ASCII codes (8/7 bits)
Signal level	Compliant with EIA RS-232C HIGH level (data logic 0): +5 to +15 V LOW level (data logic 1): -5 to -15 V
Bit configuration	Start bit: One bit Data bits: 8/7 bits ("7 bit" can be specified only for the extended 7-digit numeric format.) Parity bit: 0/1 bit Stop bits: 2/1 bit ("1 bit" can be specified only for the extended 7-digit numeric format.)
Parity bit	None/Odd/Even

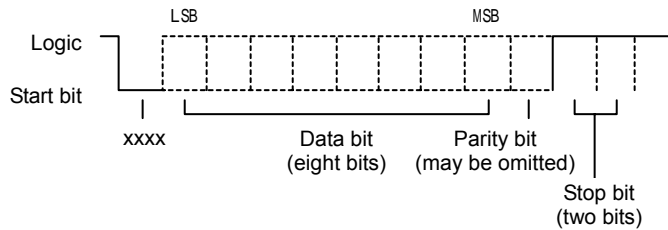

6-3 Communication Data and Commands

The RS-232C interface exchanges data with external devices as follows:

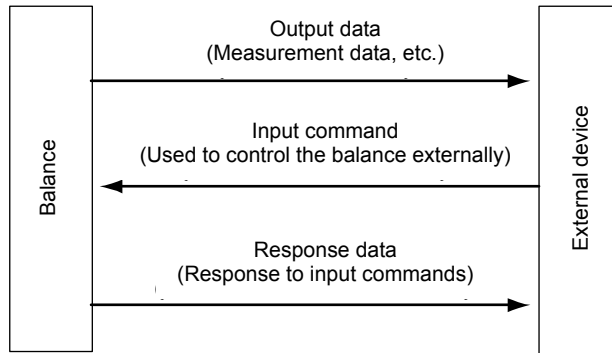

Output data

The three formats of “6-digit numeric”, “7-digit numeric”, and “extended 7-digit numeric” formats are available. Select a format with the following operation:

- 1 Set to the function setting mode.
(Refer to “Section 2-5: Function Setting Basics (P. 16).)

Press and hold the [Function] key. After “*F u n c*” is displayed, release the finger.
- 2



Press the [Function] key several times to select “*E. 1F.*”.

Press the [Zero/Tare] key to select a format.

1 = 6-digit numeric format
2 = 7-digit numeric format
3 = Extended 7-digit numeric format
- 3 Save the setting.



Press the [Set] key.

The balance goes back to normal display.

Input/Output to/from External Devices

■ Data format

- 6-digit numeric format

Consists of 14 characters including terminators (CR = 0DH/LF = 0AH).

1	2	3	4	5	6	7	8	9	10	11	12	13	14
P1	D1	D2	D3	D4	D5	D6	D7	U1	U2	S1	S2	CR	LF

- 7-digit numeric format

Consists of 15 characters including terminators (CR = 0DH/LF = 0AH). A parity bit can be appended.

1	2	3	4	5	6	7	8	9	10	11	12	13	14	15
P1	D1	D2	D3	D4	D5	D6	D7	D8	U1	U2	S1	S2	CR	LF

- Extended 7-digit numeric format

This is an extended version of the 7-digit numeric format and is different from the 7-digit numeric format in that:

- the data length can be seven bits rather than eight bits, and
- the stop bit length can be one bit rather than two bits.
- If you select Japanese (katakana) for printed language, the data length is automatically set to eight bits.

■ Meanings of data

[P1] (one character)

Indicates the polarity of data.

P1	Code	Description
+	2BH	Zero or positive data
-	2DH	Negative data

[D1 to D7 (or D8)] (seven or eight characters)

Numeric data is stored.

D1~D7(D8)	Code	Description
0~9	30H~39H	0 to 9 (numeric)
.	2EH	- Decimal point (floating) - Omitted when numeric data does not contain decimal places. In this case, a space is output to the least significant digit.
SP (Space)	20H	- A space heading a numeric value - When numeric data does not contain decimal places, a space rather than a decimal point is output to the least significant digit.

- * - If headed with no data, the numeric value is headed by 0 (30H) by factory default setting. Using the function setting, it can be headed by "SP" (20H).

- When expression units are changed or switched to display of parts counting, percentage weighing, or unit converting, the decimal place is changed (Refer to “■ Sample communication formats” (P. 70)).

[U1, U2] (two characters)

Indicates the unit used to show numeric data.

U1	U2	Code		Meaning	Balance indicator
(SP)	G	20H	47H	gram	g
K	G	4BH	47H	Kilogram	kg
C	T	43H	54H	carat	CT
O	Z	4FH	5AH	ounce	oz
L	B	4CH	42H	pound	lb
O	T	4FH	54H	troy ounce	oz t
D	W	44H	57H	pennyweight	dwt
G	R	4BH	52H	Grain	Bottom right ▷ grain
T	L	54H	4CH	tael (Hong Kong)	tl
T	L	54H	4CH	tael (Singapore, Malaysia)	tl Top right
T	L	54H	4CH	tael (Taiwan)	tl Middle right
M	O	4DH	4FH	momme	mom
t	o	74H	6FH	tola	to
P	C	50H	43H	Pieces	Pcs
(SP)	%	20H	25H	Percentage	%
(SP)	#	20H	23H	Computation results, numbers, etc.	#

[S1] (one character)

Indicates the judgment result when the limit function is used.

S1	Code	Description	Remarks
L	4CH	Below (LO)	1- or 2-point scale
G	47H	Appropriate (OK)	
H	48H	Above (HI)	
T	54H	Cumulative value	Data type
U	55H	Unit weight	
(SP)	20H	No judgment result or no data type specified	
d	64H	Gross	

Input/Output to/from External Devices

[S2] (one character)

Indicates the status.

S2	Code	Description
S	53H	Data stable *1
U	55H	Data unstable *1
E	45H	Data error *2 (Indicates that data other than S2 is invalid.)
(SP)	20H	No status specified

*1: This value is independent of data if the data is independent of whether the weighing condition is stable or not, such as cumulative values and unit weights.

*2: When “ $\square - \bar{E} r r$ ” or “ $\square - \bar{E} r r$ ” is displayed

■ Sample communication formats

- 6-digit numeric format

3000.1 g/No data type specified/Data stable

1	2	3	4	5	6	7	8	9	10	11	12	13	14
+	0	3	0	0	0	.	1	(SP)	G	(SP)	S	CR	LF

+800.05 mom/Gross/Data unstable

1	2	3	4	5	6	7	8	9	10	11	12	13	14
-	0	8	0	0	.	0	5	M	O	d	U	CR	LF

250 pcs./Cumulative value/Data stable

1	2	3	4	5	6	7	8	9	10	11	12	13	14
+	0	0	0	2	5	0	(SP)	P	C	T	S	CR	LF

- 7-digit numeric format

3000.1 g/No data type specified/Data stable

1	2	3	4	5	6	7	8	9	10	11	12	13	14	15
+	0	0	3	0	0	0	.	1	(SP)	G	(SP)	S	CR	LF

+800.05 mom/Gross/Data unstable

1	2	3	4	5	6	7	8	9	10	11	12	13	14	15
-	0	0	8	0	0	.	0	5	M	O	d	U	CR	LF

250 pcs./Cumulative value/Data stable

1	2	3	4	5	6	7	8	9	10	11	12	13	14	15
+	0	0	0	0	2	5	0	(SP)	P	C	T	S	CR	LF

Input commands

An input command is to control the balance from an external device. The following four input commands are supported:

- (1) Tare range command (2) Set output control command (3) Set measurement mode command (4) Span adjustment/test command

■ Procedure for transmission

- (1) An input command is sent from an external device to the balance.
The full-duplex transmission system allows you to send an input command at any time independently of the data transmit timing of the balance.
- (2) Upon successful completion of an input command, the balance will send out either a normal completion response or the result data requested by the command, to the external device.
- If the operation has not resulted in successful completion, or if the command is invalid (in error), the balance will transmit an error response.
 - When the balance is in normal display mode, it usually sends a response to a command within one second after it is received. For a tare range command and a span adjustment/test command, a response is sent after the command is completely processed.
 - If the balance receives a tare range command when the tare range setting (Function setting: $H_t r$) is set so that the display is reset to “0” when the balance is stabilized (waiting for tare range setting to be stable), or if the balance receives an input command that takes a long time, the balance sends a response after the command is completely processed.
 - If the balance receives a command when you are setting a function, when the balance is under span adjustment, or the balance is busy for other reasons, the command is executed after that operation is completed.

Caution	After you have sent an input command, do not send another command to the balance until the external device receives a response from the balance.
----------------	--

■ Sample input commands

Sent command	Description
T(SP)(CR)(LF)	Set tare range (adjust to zero-point).
01(CR)(LF)	Set to continuous output.
08(CR)(LF)	Output data (once immediately).

■ Command form

An input command consists of 4 characters including terminators (CR/LF).

C1	C2	CR	LF
----	----	----	----

Input/Output to/from External Devices

■ Command format

(1) Tare range (zero-point adjustment) command

C1	C2	Code (C1)	Code (C2)	Description	Value	Response
T	(SP)	54H	20H	<ul style="list-style-type: none">- Tare range setting- Zero-point adjustment	None	A00: Successful completion E01: Command error E04: A tare range (zero-point adjustment) cannot be set (Range violation, weight error, etc.).

(2) Set output control command

C1	C2	Code (C1)	Code (C2)	Description	Response
O	0	4FH	-{}-30H	Stop output.	A00: Successful completion E01: Command error
O	1	4FH	31H	Output continuously at all times.	
O	2	4FH	32H	Output continuously if stable (Stop output if unstable).	
O	3	4FH	33H	Output once when the [Print] key is pressed (whether the balance is stable or unstable).	
O	4	4FH	34H	Output once when the balance is stable. Output when a sample is lifted to cause the display to indicate a value below zero, and then another sample is placed to make the balance stable.	
O	5	4FH	35H	Output once when the balance is stable. Stop output when unstable. Output once when the balance is stabilized again (the output includes zero) even if it is not reloaded.	
O	6	4FH	36H	Output once when the balance is stable. Output continuously when unstable. Output is stopped after a single output when the balance is stable even if it is not reloaded.	
O	7	4FH	37H	Output once when the [Print] key is pressed if the balance is stable.	
O	8	4FH	38H	Output once immediately.	
O	9	4FH	39H	Output once after stabilized.	

- Commands O0 to O7 have the same workings as the output control set by the function setting.
- Commands O8 and O9 are used to request data from the balance.
- Once executed, O0 to O7 commands are held. However, the status is reset to the function setting when the balance is turned on again.
- When either an O8 or O9 command is executed, it returns to the state of "O0".

Input/Output to/from External Devices

(3) Set measurement mode command

C1	C2	Code (C1)	Code (C2)	Description	Response
M	1	4DH	31H	Set to Mode 1	A00: Successful completion E01: Command error E02: Error
M	2	4DH	32H	Set to Mode 2	
M	3	4DH	33H	Set to Mode 3	
M	4	4DH	34H	Set to Mode 4	

* The measurement mode to be activated by the above mode settings 1 to 4 depends on the weighing mode currently in use.

- Relationship between weighing mode and mode setting

Mode	Weighing machine	Parts counting	Percentage weighing	Unit converting	Gravimeter	Animal weighing
Mode 1	Weight measuring	Weight measuring	Weight measuring	Weight measuring	Error	Error
Mode 2	Gross weight	Parts counting	Percentage measuring	Coefficient multiplying	Error	Error
Mode 3	Cumulative weight*1	Cumulative count*1	Cumulative percent*1	Cumulative sum*1	Error	Error
Mode 4	Display in unit B*2	Average unit weight	Error	Error	Error	Error

*1: Mode 3 (M3) can be specified only when the addition function is to be used. If the addition function is not enabled, it results in an error.

*2: If a unit is NOT specified for unit B, the balance is set for the weight measuring mode. When you specify a mode that is not supported by the current Weighing Mode, an error is returned from the balance.

(4) Span adjustment/test command

C1	C2	Code (C1)	Code (C2)	Description	Response
C	0	43H	30H	Disables command inputs.*1	A00: Successful completion E01: Command error E02: Operation is disabled. E03: Cancelled by operation E04: Abnormal completion
C	3	43H	33H	Span adjustment with external weight	
C	4	43H	34H	Span test with external weight	

*1: A span adjustment and test commands will also be disabled.

* This command takes time because the balance sends back a response after an appropriate operation is completed.

* If set to “[Cal] key disabled” (0) in the function setting “ \overline{CAL} ”, a span adjustment and test command does not work.

Response

Upon receiving an input command, the balance sends out a response.

You can select the response format of either the ["A00"/"Exx"] format or the [ACK/NAK] format. In the explanation of "input commands" in the previous section, the ["A00"/"Exx"] format responses are described.

- ["A00"/"Exx"] format

Consists of five characters including terminators. For more information on A1 to A3, see the "Response" fields in the previous section.

A1	A2	A3	CR	LF
----	----	----	----	----

- [ACK/NAK] format

Consists of one character without a terminator. "Successful completion" (ACK) or "Abnormal completion" (NAK) is returned.

Response	Code	Meaning
ACK	06H	Successful completion
NAK	15H	<ul style="list-style-type: none"> - Command error (when an errant command is received) - Numeric format error - Processing interrupted - Processing terminated abnormally - Other errors

Reference

To switch between ["A00"/"Exx"] format and [ACK/NAK] format, use the function setting "5 7.5".

1: ["A00"/"Exx"] format

2: [ACK/NAK] format

Troubleshooting

This chapter describes troubleshooting including error messages and remedies.

This chapter includes:

Error Messages

Troubleshooting

Initializing

Maintenance

7-1 Error Messages

Message	Cause	Remedy
<i>0 - E r r</i>	<ul style="list-style-type: none"> - The weight of the sample is over the weighing capacity - The number of digits in the addition result or calculation result went over the number that can be displayed. 	<ul style="list-style-type: none"> - Unload the sample to weigh it in some portioned-out measurements. - Replace the tare with a lighter one. - If the error message does not disappear even when nothing is placed on the pan, mechanical parts may have failed. Contact our dealer. - First, clear the addition result. Then execute addition again. - The coefficient used in unit converting is too small. Set a greater coefficient.
<i>⊖ - E r r</i>	The minus-value load exceeded the lower limit.	<ul style="list-style-type: none"> - The pan or the pan base may not be properly set. Check them, paying attention to whether they are in contact with an external object. - If the error message does not disappear even if the pan and the pan base are properly set, mechanical parts may have failed. Contact our dealer.
<i>1 - E r r</i>	The reference weight used during span adjustment with an external weight is far less than 50% of the weighing capacity.	For span adjustment with an external weight, use a weight that weighs as close to the weighing capacity as possible.
<i>2 - E r r</i>	An error over 1.0% was detected in span adjustment with an external weight, or the balance failed.	For span adjustment with an external weight, check that a correct weight is placed and that no objects other than the weight are placed. Then, execute span adjustment again.

<i>b - E r r</i>	The balance is influenced by static electricity or noise.	<ul style="list-style-type: none"> - Unplug the AC adapter from the receptacle and then turn the power on again. - If this error occurs again, electric components may have failed. Contact our dealer.
<i>d - E r r</i>	The balance is influenced by static electricity or noise.	<ul style="list-style-type: none"> - Unplug the AC adapter from the receptacle and then turn the power on again. - If this error occurs again, electric components may have failed. Contact our dealer.
<i>L - E r r</i>	The weight of a sample is too light at a sampling during parts counting, or reference weight saving during percentage weighing.	Use a heavier sample by referring to the Specifications (P. 93) to check the minimum unit weight and the percentage weighing weight limit.
<i>t - E r r</i>	<ul style="list-style-type: none"> - At addition operation, you placed additional samples on twice. - At addition operation, you unloaded some samples or you pressed the key without adding samples. 	<ul style="list-style-type: none"> - After setting the display to "0" (by unloading the previous sample), place the next sample to continue addition operation. - Addition operation is impossible when 0 or a negative value is displayed. Place a sample to continue addition operation.
<i>E 1 - E r r</i>	No inputs are sent from the weight sensor.	<ul style="list-style-type: none"> - Unplug the AC adapter from the receptacle and then turn the power on again. - If this error occurs again, the sensor may have failed. Contact our dealer.
<i>E 2 - E r r</i>	Because the balance is unstable, initialization cannot be completed.	The balance may be affected by an external influence such as wind and vibration. Relocate the balance by referring to the section "Do not use the balance in the following places" (P. v).

7-2 Troubleshooting

Problem	Cause	Remedy
Nothing is displayed even when the balance is powered on.	The AC adapter is not connected.	<ul style="list-style-type: none"> - Check that the AC adapter is connected. - If nothing is displayed even if the AC adapter is properly connected, the electric components of the balance, or the AC adapter may have failed. Replace the AC adapter to test the root cause of the problem, if you have a same-model AC adapter that operates properly at hand. - Contact our dealer.
	The batteries are exhausted.	Replace the batteries.
Display flickers.	The balance may be affected by an external influence such as wind and vibration.	Increase the setting values of relevant functions by referring to “Section 5-6: Improving the Stability of the Balance” (P. 59).
Weight indication contains an error.	The display error is caused because the balance has not been used for a long period of time or has been relocated to another location.	Perform span adjustment.
	The adjusters are not settled, and the balance is not kept horizontal.	Check that the balance is kept horizontal.
	The tare weight is set or not.	Unload the sample from the pan and then zero the readout by pressing the [Zero/Tare] key to continue measurement.

Problem	Cause	Remedy
Weight indication contains an error even after calibrated.	The balance may have been affected by an external influence such as wind and vibration during calibration.	The balance may be affected by an external influence such as wind and vibration. Take remedial actions or relocate the balance by referring to the section “Do not use the balance in the following places” (P. v). Then calibrate again.
	The weight used for calibration is slightly different in mass from the weight used for checking.	Use the same weight during calibration and checking.
The display does not move with the M sign flashing. (When the [Zero/Tare] key is pressed, during a sampling in parts counting mode, etc.)	The balance may be affected by an external influence such as wind and vibration.	The balance may be affected by an external influence such as wind and vibration. Take remedial actions or relocate the balance by referring to the section “Do not use the balance in the following places” (P. v).
The icon blinks when the balance is operated on batteries.	The batteries are exhausted.	Replace the batteries.
The display is turned off when the balance is operated on batteries.	The display was turned off by the auto power off function.	The auto power off function is activated if the balance is left unused with no measurement taken for approximately five minutes. Disable the auto power off function if it interferes with your use of the balance.

Troubleshooting

Problem	Cause	Remedy
No outputs	Intended output function settings are not established.	<p>Make the balance compatible in communication conditions with the external device by referring to their operation manuals.</p> <p>Check outputs with the following methods:</p> <p>Initialize the function settings by referring to “Section 7-3: Initializing (P. 83) or Function Setting List.</p> <p>Then, set to a communication condition of 1,200 bps, 8-bit data, 2-bit stop bit, and no parity by referring to the operation manual of the external device.</p> <p>Now, output is done once after stabilization, after the [P] key is pressed. Check output by pressing the [P] key.</p>
	Communication conditions disagree with the external device.	
	Wrong cable connection	<p>To connect the balance to a general-use PC, a cross cable is required (Refer to “Section 6-2: Connecting to External Devices via RS-232C Interface” (P. 64)).</p> <p>Arrange it yourself or contact our dealer.</p>
	The cable is disconnected or not properly connected.	Check for proper cable connection.
The current settings of the balance are unknown.		You can initialize the balance (“Section 7-3: Initializing” (P. 83)).

7-3 Initializing

The settings of the balance can be initialized with the following steps:

1

Set to the function 2 setting mode.

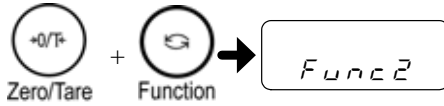

Press the [Function] key while pressing the [Zero/Tare] key. Release the fingers when "Function 2" is displayed.

The function 2 setting mode is set, displaying "1.1 d 0".

2

Set the function initialization.



Select "2.1 d 1" by pressing the [Function] key.

Select "1" by pressing the [Zero/Tare] key.

3

Save the setting.



Press the [Set] key.

The balance goes back to normal display.

Caution

All function settings are initialized, discarding all data including ID numbers, limit values, data of parts counting, percentage weighing, unit converting, and gravimeter. Restoring the current status will be impossible. Before initializing the balance, record necessary function settings in a memo or otherwise.

7-4 Maintenance

When taking care of the balance, be careful of the following:

For heavy dirt

If the balance is very dirty, disassemble and clean it.

The parts that you can remove are only the pan and the pan base.

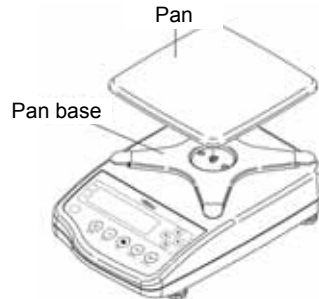

Caution

Removing parts other than the pan and the pan base damages the waterproof function of the balance, resulting in possible failure.

How to take care of the balance

To clean the main unit, use a piece of dry soft cloth.

If the unit is very dirty, use a cloth soaked in a small quantity of neutral detergent or cleaning solvent.

If the unit is extremely dirty, wash it with water and dry it well with a dry cloth.

Caution

When washing the main unit with water, do not submerge it in water.
Check that the power cap, the RS232 connector cap, and the battery case are tightly attached.
Do not scratch the diaphragm and the bottom ventilation hole using a sharp object, hard brush, or other such hazardous tools.

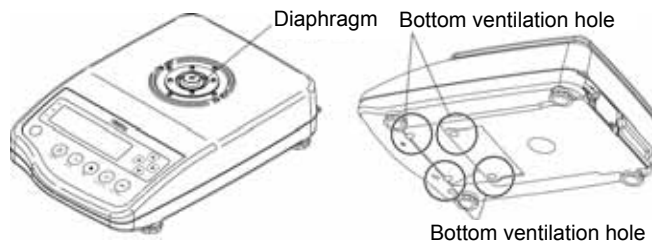

Appendixes

The appendixes provide data including each type of data for the balance.

This chapter includes:

Function Setting List

Measurement Mode List

Printing in Compliance with ISO/GLP/GMP

Specifications

Appendix 1 Function Setting List

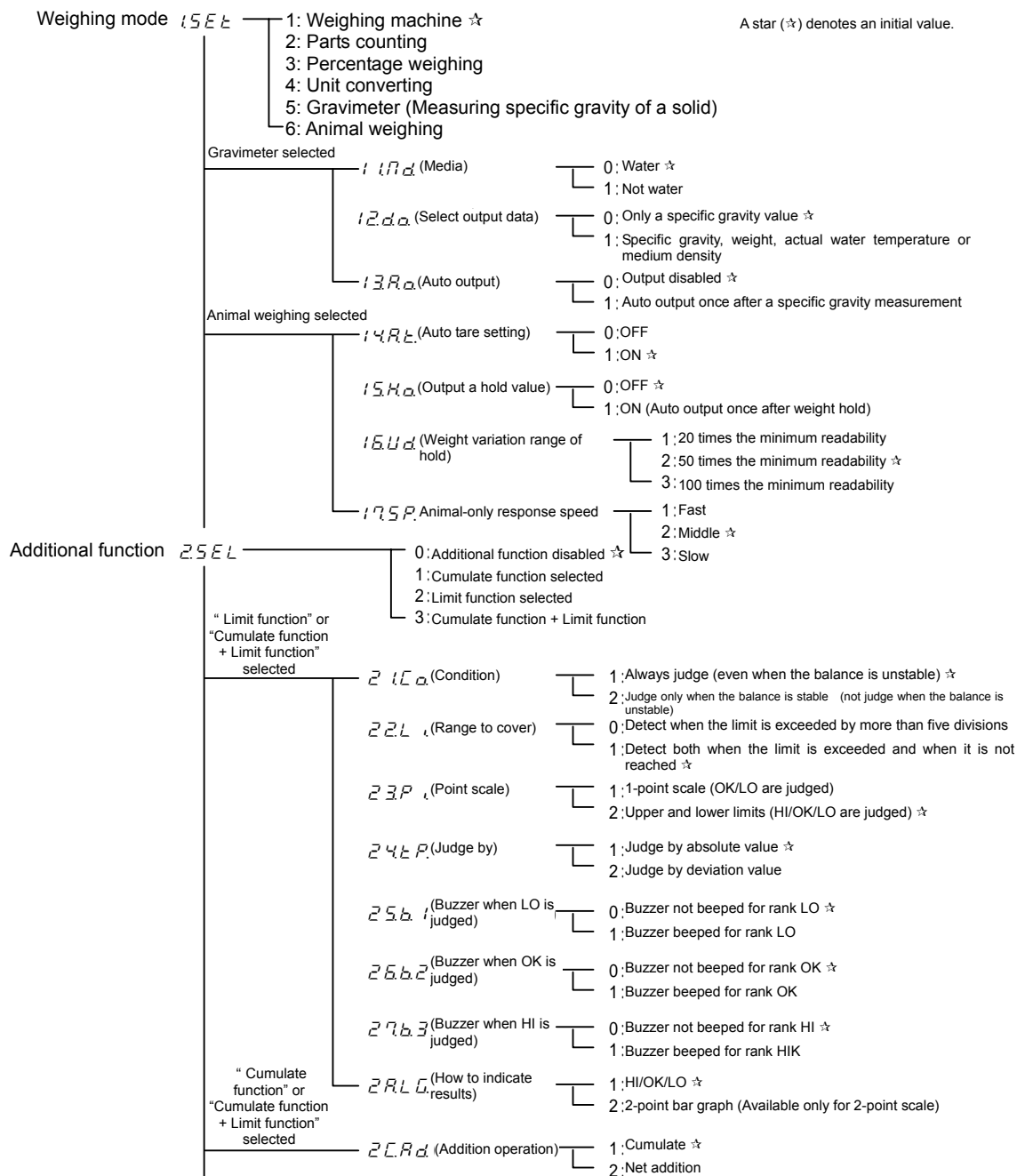

(Continued on next page.)

Appendix 1 Function Setting List

A star (☆) denotes an initial value.

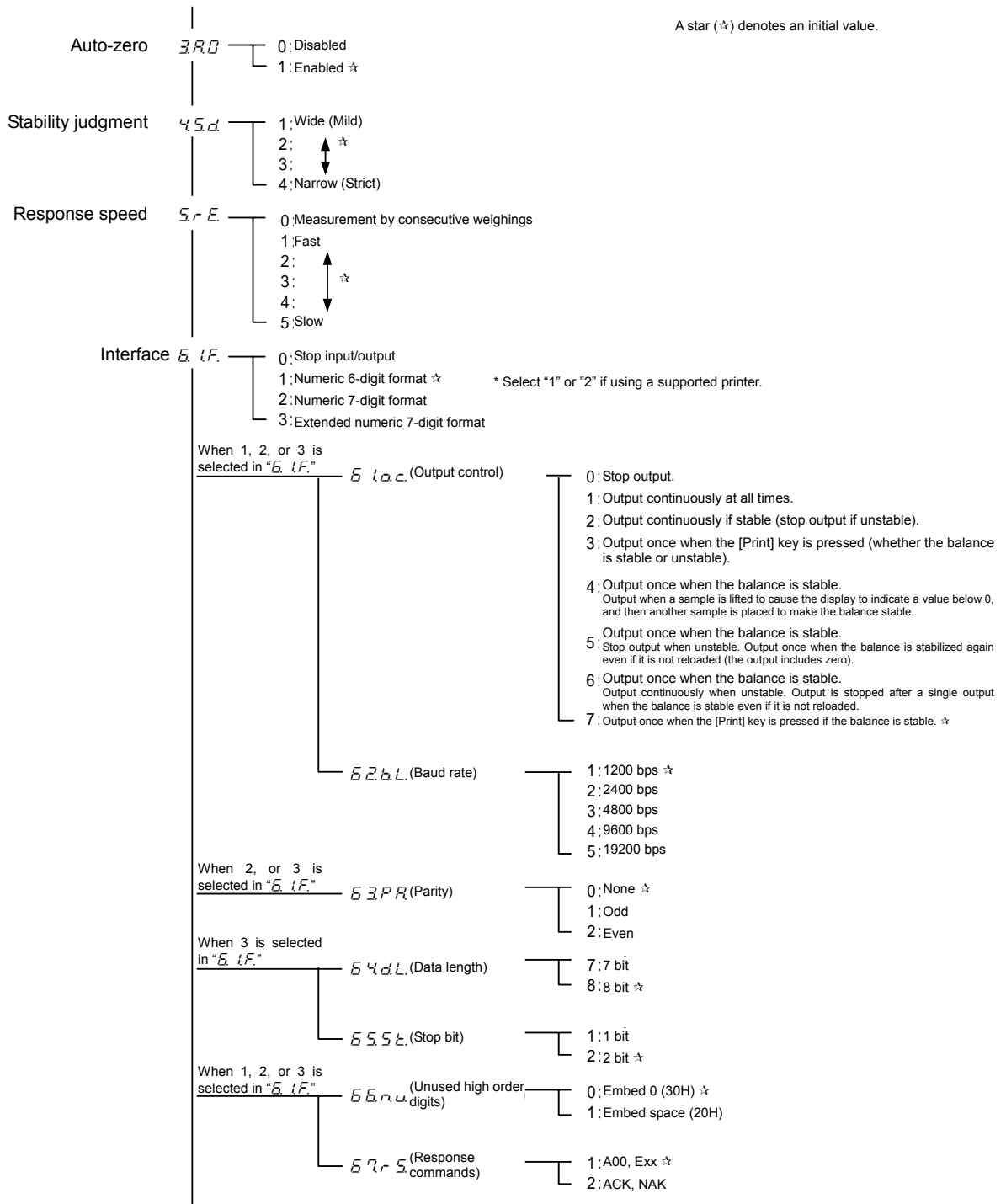

(Continued on next page.)

A star (☆) denotes an initial value.



(Continued on next page.)

Appendix 1 Function Setting List

A star (☆) denotes an initial value.

Set tare range	$H \bar{L} R$	<ul style="list-style-type: none"> 1: "0" is displayed immediately after the key is pressed. 2: Reset the display to "0" when the balance is stabilized. ☆
Store tare	$\bar{L} \bar{R} \bar{R}$	<ul style="list-style-type: none"> 0: Disabled ☆ 1: Enabled
Buzzer control	$\bar{R} b \bar{Z}$	<ul style="list-style-type: none"> 0: Off 1: On (Beeps when a value is confirmed, wrong operation is made, etc.) 2: Beeps when the key is pressed in addition to the beeping situations in 1. ☆
		$\bar{R} \bar{L} \bar{R}$ (Buzzer tone) <ul style="list-style-type: none"> 1: Low 2: Middle ☆ 3: High <p>* When "1" or "2" is selected in "$\bar{R} b \bar{Z}$"</p>
Backlight control	$\alpha b \bar{L}$	<ul style="list-style-type: none"> 0: Off 1: On 2: On when the balance is powered by the AC adapter. Off when powered by batteries. ☆

Appendix 2 Measurement Mode List

In each weighing mode, pressing the [Function] key can toggle the function displayed. Displayable functions differ between modes. The additional functions usable concurrently in each function also differ.

Weighing mode	Displayed functions switched at each [Function] key press				Additional function usable in each function		Remarks
	Switching order	Displayed function	Unit used	Displayed sign	Addition	Limit	
Weighing machine	1	Weight measuring	Unit A		○	○	
	2	Gross weight	Unit A	B/G	×	×	
	3	Weight measuring	Unit B		×	×	Displayed only when unit B is selected
	4	Cumulative weight	Unit A	Σ	Cumulative value	×	Displayed only when addition function is selected
Parts counting	1	Parts counting	Pcs		○	○	
	2	Cumulative count	Pcs	Σ	Cumulative value	×	Displayed only when addition function is selected
	3	Average unit weight	Unit A	Pcs	×	×	
	4	Weight measuring	Unit A		×	×	
Percentage weighing	1	Percentage measuring	%		○	○	
	2	Cumulative percent	%	Σ	Cumulative value	×	Displayed only when addition function is selected
	3	Weight measuring	Unit A		×	×	
Unit converting	1	Coefficient multiplying	#		○	○	
	2	Cumulative sum	#	Σ	Cumulative value	×	Displayed only when addition function is selected
	3	Weight measuring	Unit A		×	×	
Gravimeter	1	Measurement of specific gravity	g		×	×	Unit for weight fixed to g
Animal weighing	1	Weight measuring	g		×	×	Unit for weight fixed with g Holding function always enabled

* For more information on unit A and unit B, refer to “Section 5-1: Using Two Expression Units by Switching Them” (P. 52).

Appendix 3 Printing in Compliance with ISO/GLP/GMP

■ Span adjustment with external weight

English	Japanese (katakana)
<pre> **CALIBRATION** DATE: 10. 07. 2008 TIME: 13:30 SHINKO DENSHI TYPE: CJ-3200E S/N:0807301 ID: 101 CAL. EXTERNAL REF: 3200.00 g COMPLETE DATE:2008. 07. 10 TIME: 13:31 SIGNATURE ***** </pre>	<pre> *** コウセイ *** ヒヅケ: 10. 07. 2008 ジユク: 13:30 SHINKO DENSHI カタシキ: CJ-3200E セイバ`ン:0807301 ID: 101 コウセイ(カ`イフ`ンド`ウ キジ`ユン: 3200.00 g シュウリョウ ヒヅケ:2008. 07. 10 ジユク: 13:31 シヨメイ ***** </pre>

■ Span test with external weight

English	Japanese (katakana)
<pre> **CAL. TEST***** DATE: 10. 07. 2008 TIME: 13:30 SHINKO DENSHI TYPE: CJ-3200E S/N:0807301 ID: 101 CAL. EXT. TEST REF: 3200.0 g DIFF: 0.0081 g COMPLETE DATE:2008. 07. 10 TIME: 13:31 SIGNATURE ***** </pre>	<pre> *** テスト *** ヒヅケ: 10. 07. 2008 ジユク: 13:30 SHINKO DENSHI カタシキ: CJ-3200E セイバ`ン:0807301 ID: 101 テスト(カ`イフ`ンド`ウ キジ`ユン: 3200.0 g ゴ`サ: 0.0081 g シュウリョウ ヒヅケ:2008. 07. 10 ジユク: 13:31 シヨメイ ***** </pre>

■ Measurement data: Header

English	Japanese (katakana)
SHINKO DENSHI TYPE: CJ-3200E S/N: 0807301 ID: 101 START DATE: 10. 07. 2008 TIME: 13:30	SHINKO DENSHI カタシキ: CJ-3200E セイバ ^ン : 0807301 ID: 101 カイシ ヒツケ: 10. 07. 2008 ジ ^コ ク: 13:30

■ Measurement data: Footer

English	Japanese (katakana)
END DATE: 10. 07. 2008 TIME: 14:30 SIGNATURE *****	シュウリョウ ヒツケ: 10. 07. 2008 ジ ^コ ク: 14:30 ショメイ *****

Caution	The date and time shown in printing examples are printed only when the dedicated printer (CSP-160) is used.
----------------	---

Appendix 4 Specifications

■ Basic specifications

Model	Gram (g)		Parts counting	Percentage	Dimension of pan
	Weighing capacity	Minimum readability (d)	Minimum unit weight (g)	Weight limit (g)	
CJ-220E	220	0.01	0.01	1	φ140 mm
CJ-320E	320				
CJ-620E	620				
CJ-820E	820				
CJ-2200E	2200	0.1	0.1	10	190 × 190 mm
CJ-3200E	3200				
CJ-6200E	6200				
CJ-8200E	8200				
CJ-15KE	15000	1	1	100	

■ Functional specifications

Weighing system	Tuning fork system
Weighing mode	Weighing machine/Parts counting/Percentage weighing/Unit converting/Gravimeter (Measuring specific gravity of a solid)/Animal weighing
Function	Cumulate function/Net addition/Limit (3-point scale judgment with upper and lower limit setting, absolute/deviation value judgment)/Unit converting/ISO/GLP/GMP compliant/Tare storing/Minimum readability switching/Unit weight showing/Gross weight showing/Auto backlight off/Auto power off/Built-in buzzer
Display	LCD (with backlight) The LCD 7-segment can display up to six digits (six digits for a weight). The segment is max. 18 mm high. Can display a bar graph of up to 20 bars, and various messages.
Tare range	The weight of the tare actually placed on the balance is set as a weight by just pressing the [Zero/Tare] key (Whether to wait for the balance to stabilize is selectable).
Zero tracking	Can be disabled by setting.
Display when overloaded	“ $\square - E r r$ ” is displayed when the weighing capacity is exceeded by 9 divisions.

Output	RS-232C compliant output is equipped as standard. SHINKO DENSHI standard format D-SUB9P male (RS-232C output, port for external tare range setting, bi-directional) Supported printer: CSP-160 (SHINKO DENSHI)
Span adjustment	Span adjustment/test with external weights (Weights used are at least 50% of the weighing capacity) * Only the unit g can be used for span adjustment.
Power	Dedicated AC Adapter: 6VDC/100 to 120VAC or 6VDC/230VAC
Outside dimensions	310 mm (depth) × 208 mm (width) × 87 mm (height)
Weight of the main unit	CJ-220E to CJ-820E: Approximately 2 kg CJ-2200E to CJ-15KE: Approximately 2.5 kg
Operating temperature/ humidity	Temperature: 0 to +40°C, Humidity: 80%rh or less (No condensation allowed)
Options	CJ buzzer option/CJ limit contact output option/CJ full-pack option/CJ RS422 option (D-SUB9P)/Direct start option/CJ optional battery unit/CJ underfloor weigher fixture option

When using options, be careful of the following:

Reference

- When using the RS422 option, D-SUB9P is RS422 (Cannot be used together with RS232C).
 - Optional battery unit, limit contact output option, buzzer, and full-pack option cannot be used together.
 - The optional battery unit does not include batteries (use four AA batteries).
-

■ Minimum Display by Unit of Measurement

Model Unit_of measurment	CJ- 220E	CJ- 320E	CJ- 620E	CJ- 820E	CJ- 2200E	CJ- 3200E	CJ- 6200E	CJ- 8200E
g	220 0.01	320 0.01	620 0.01	820 0.01	2200 0.1	3200 0.1	6200 0.1	8200 0.1
kg	0.22 0.00001	0.32 0.00001	0.62 0.00001	0.82 0.00001	2.2 0.0001	3.2 0.0001	6.2 0.0001	8.2 0.0001
ct (ct)	1100 0.05	1600 0.05	3100 0.05	4100 0.05	11000 0.5	16000 0.5	31000 0.5	41000 0.5
oz (oz)	7.7 0.0005	11 0.0005	21 0.0005	28 0.0005	77 0.005	110 0.005	210 0.005	280 0.005
lb (lb)	0.48 0.00005	0.7 0.00005	1.3 0.00005	1.8 0.00005	4.8 0.0005	7.0 0.0005	13 0.0005	18 0.0005
oz t (ozt)	7 0.0005	10 0.0005	19 0.0005	26 0.0005	70 0.005	100 0.005	190 0.005	260 0.005
dwt (dwt)	140 0.01	200 0.01	390 0.01	520 0.01	1400 0.1	2000 0.1	3900 0.1	5200 0.1
Bottom right ▷ grain	3300 0.2	4900 0.2	9500 0.2	12000 0.2	33000 2	49000 2	95000 2	120000 2
ti (Hong Kong)	5.8 0.0005	8.5 0.0005	16 0.0005	21 0.0005	58 0.005	85 0.005	160 0.005	210 0.005
ti (Singapore, Malaysia)	5.8 0.0005	8.4 0.0005	16 0.0005	21 0.0005	58 0.005	84 0.005	160 0.005	210 0.005
ti (Taiwan)	5.8 0.0005	8.5 0.0005	16 0.0005	21 0.0005	58 0.005	85 0.005	160 0.005	210 0.005
mom (momme)	58 0.005	85 0.005	160 0.005	210 0.005	580 0.05	850 0.05	1600 0.05	2100 0.05
to (to)	18 0.001	27 0.001	53 0.001	70 0.001	180 0.01	270 0.01	530 0.01	700 0.01

* The view of the table

Model Unit_of measurament	CJ- 15KE
g	15000 1
kg	15 0.001
ct (ct)	75000 5
oz (oz)	520 0.05
lb (lb)	33 0.005
oz t (ozt)	480 0.05
dwt (dwt)	9600 1
Bottom right ▷ grain	
tl (Hong Kong)	400 0.05
tl (Singapore, Malaysia)	390 0.05
tl (Taiwan)	400 0.05
mom (momme)	4000 0.5
to (to)	1200 0.1

* The view of the table

Upper cell: Capacity
Lower cell: Readability

Appendix 5 Conversion Table Units

Unit	Gram	carat	Ounce	Pound	troy ounce	Penny Weight
1 g	1	5	0.03527	0.00220	0.03215	0.64301
1 ct	0.2	1	0.00705	0.00044	0.00643	0.12860
1 oz	28.34952	141.74762	1	0.06250	0.91146	18.22917
1 lb	453.59237	2267.96185	16	1	14.58333	291.66667
1 ozt	31.10348	155.51738	1.09714	0.06857	1	20
1 dwt	1.55517	7.77587	0.05486	0.00343	0.05	1
1 GN	0.06480	0.32399	0.00229	0.00014	0.00208	0.04167
1 tl (HK)	37.429	187.145	1.32027	0.08252	1.20337	24.06741
1 tl (SGP,Mal)	37.79936	188.99682	1.33333	0.08333	1.21528	24.30556
1 tl (Taiwan)	37.5	187.5	1.32277	0.08267	1.20565	24.11306
1 mom	3.75	18.75	0.13228	0.00827	0.12057	2.41131
1 to	11.66380	58.31902	0.41143	0.02571	0.37500	7.5

unit	Grain	tael (Hong Kong)	tael (Singapore, Malaysia)	tael (Taiwan)	momme	Tola
1 g	15.43236	0.02672	0.02646	0.02667	0.26667	0.08574
1 ct	3.08647	0.00534	0.00529	0.00533	0.05333	0.01715
1 oz	437.5	0.75742	0.75	0.75599	7.55987	2.43056
1 lb	7000	12.11874	12	12.09580	120.95797	38.88889
1 ozt	480	0.83100	0.82286	0.82943	8.29426	2.66667
1 dwt	24	0.04155	0.04114	0.04147	0.41471	0.13333
1 GN	1	0.00173	0.00171	0.00173	0.01728	0.00556
1 tl (HK)	577.61774	1	0.99020	0.99811	9.98107	3.20899
1 tl (SGP,Mal)	583.33333	1.00990	1	1.00798	10.07983	3.24074
1 tl (Taiwan)	578.71344	1.00190	0.99208	1	10	3.21507
1 mom	57.87134	0.10019	0.09921	0.1	1	0.32151
1 to	180	0.31162	0.30857	0.31103	3.11035	1

Index for Terms

[A]

Absolute value	38
AC adapter.....	2, 8
Adjuster	9
Animal	34
Auto backlight off.....	56
Auto power off.....	55
Average sample weight	22

[B]

Bar graph	12, 38
Battery	vi

[C]

Calibrate	48
Carat	52
Coefficient	26
Command	71
Cumulate.....	36

[D]

Deviation value.....	38, 43
D-SUB9P cable.....	62

[F]

Function setting	16
------------------------	----

[G]

Gross.....	15
------------	----

[I]

ID numbers	57
Initializing.....	83
Interface.....	66
ISO/GLP/GMP compliant form	62

[L]

Limit value.....	39
Liquid density	31

[M]

Minimum readability	53
Momme	52

[N]

Net.....	15
Net addition.....	36
Number of samples.....	21

[O]

Operation key	5
---------------------	---

[P]

Pan.....	2, 8, 84
Pan base.....	2, 8, 84
Percentage	23
Press and hold	5
Printer.....	62

[R]

Reference weight.....	25
Response	75
RS-232C.....	62, 64

[S]

Sample.....	21
Sample.....	28
Span adjustment	48
Span test	50
Specific gravity	28
Stability	59

[T]

Tare.....	13, 54
Terminators	71

[U]

Underfloor weigher	28
Unit	52

[W]

Waterproof and dustproof.....	iii
Weighing capacity	13, 93
Weight	48
Weight limit.....	25

