

# Intrinsically Safe Explosion-Proof High-Precision Tuning Fork Scale

## F Z - E x Series

## Operation Manual

### **IMPORTANT**

- To ensure safe and proper use of the balance, please read this manual carefully.
- After reading this manual, store it in a safe place near the balance, so you can review it as needed.

SHINKO DENSHI CO., LTD.



# Preface

---

Thank you very much for having purchased our dust- and water-proof intrinsic safety explosion-proof structure electronic scale.

This document is the Operation Manual for the following dust- and water-proof intrinsic safety explosion-proof structure electronic scale.

In the first place, install this product properly referring to the Installation Manual attached separately, and then read this document.

# Instructions

- The copyright of this document belongs to SHINKO DENSHI CO., LTD. Reprinting or duplicating of all or part of this document without notice shall not be allowed.
- Please note that product improvement or modification may cause partial discrepancy between the product and the description of this document.
- The description of this document is subject to change without notice.
- This document has been created carefully. If, however, any error or imperfection is found by any chance, please let us know.
- Documents of which pages are missing or irregularly bound will be exchanged. Please inform the store where you purchased the product or our sales department.
- Trouble related to the product or system will be dealt with in accordance with the individual maintenance contract. Please note, however, that we will not take responsibility for consequential trouble such as discontinuation of operation caused by the product trouble.
- **VIBRA** is the registered trademark of SHINKO DENSHI CO., LTD. Company names and product names appearing in this document are the trademarks or registered trademarks of the respective company concerned.

# Important Notice

---



- It should be known that this product contains potential danger. And so please be sure to observe this document when installing, operating or servicing this product.
- SHINKO DENSHI CO., LTD. will not take any responsibility for any injury or damage caused by the non-observance of this document or misuse or unauthorized modification of this product.









- Potential dangers are increasing in the industrial equipment industries due to the advent of new materials and processing methods, and speeding up of machines. It is impossible to foresee all situations related to these dangers. In addition, there are so many “impossible” and “don’ts” and so writing all of them in the operation manual is impossible. Therefore, it is safe to think that what is not written in the operation manual “cannot be performed” unless the operation manual positively writes “it is possible.” When performing installation, operation, maintenance or inspection of this product, not only observe what is written or indicated in this document or on the product surface but also pay adequate consideration to safety measures.
- The copyright of this document is held and reserved by SHINKO DENSHI CO., LTD. Duplicating or disclosing its drawings and engineering materials without prior approval of SHINKO DENSHI CO., LTD. in writing is not permitted.
- For any question or further information concerning this document, please contact the store where you purchased the product or with its model (type) name and serial number informed.
- Manufacturer: SHINKO DENSHI CO., LTD.  
Adress: 3-9-11 Yushima, Bunkyo-ku, Tokyo 113-0034 JAPAN

# How to use this document

---

## ■ Symbols used in this document

Understand the meaning of the following symbols and observe the instructions of this document.

Symbols	Meaning
	Used for the situation that invites an imminent risk of death or severe injury unless avoided.
	Used for the situation that invites a risk of death or serious injury unless avoided.
	Used for the situation that damages device/equipment, or destructs, deletes or overtypes data unless avoided.
	Used for the situation in which special care should be taken or specific information is emphasized
	Used for reference information on operation
	Used for “Prohibition” items
	Used for “Mandatory” items requiring positive action
	Used for prohibition items to avoid “Electrical shock”.
	This symbol indicates a legal metrology.

■About how to read this document

This document consists of the following contents:

1 When beginning to use	Describes about operating precautions, names and functions of each section, etc. Please be sure to read this section when using this product for the first time.
2 Basic usage	Describes about basic usage related to weighing such as how to turn on and off the power in addition to the setting procedures to set various functions.
3 Functions related to the operation	Describes about setting items to change the operation of the scale.
4 Functions related to the performance	Describes about setting items related to the indication stability and the response speed of the scale.
5 User information setting	Describes about setting items related to the various user's IDs, and their upper and lower limits.
6 External input/output functions	Describes about setting items related to the specifications and conditions in regard to the external communication.
7 Functions related to the lock	Describes about setting items related to change prohibitions and invalid keystrokes on each menu item.
8 Controlling and adjustment functions	Describes about setting items related to the scale ID setting, the span adjustment and the date and time setting.
9 Execution menu	Describes about menus other than setting menus.
10 When this is the case	Describes about methods of troubleshooting this product such as how to respond to errors and when you are in need of help.
Appendix	Provides necessary data such as the specifications of this product.

■Symbols used in this document

Understand the meaning of the following symbols and observe the instructions of this document.

This product /The product	Refers to the product.
[On/Off] key	The name of an operation key located in front of the main unit is represented in a bracket ([ ]).
"Mode"	A message on the display is represented in double quotation marks (" ").
Push the key	Signifies pushing lightly an operation key once.
Push the key long	Signifies keeping pushing an operation key until the designated indication appears.

# Contents

---

Preface .....	i
Important Notice .....	iii
How to use this document .....	iv
Contents .....	vi
1 Prior to use .....	1
1-1 Precautions .....	1
1-2 Names and functions of each section.....	3
1-3 Performance of operation keys.....	4
1-4 How to interpret the display .....	5
1-4-1 Main LCD.....	5
1-4-2 Sub LCDs ( i03 only).....	6
1-4-3 LCD character font.....	6
2 Basic usage .....	7
2-1 Turning on / off the power, and checking for the operation .....	7
2-2 Making a zero adjustment .....	8
2-2-1 Zero adjustment range when in use.....	9
2-3 Weighing an object placed on a container (tare) .....	10
2-4 Weighing with an object to be weighed added .....	11
2-5 Selecting the main LCD indication.....	12
2-6 Selecting the sub LCD indication ( i03 only).....	12
2-7 Basic operation.....	13
2-7-1 Hierarchy of a setting menu .....	13
2-7-2 Operation of the setting menu, setting of various functions .....	14
2-7-3 Operation of the setting menu, inputting of numeric values .....	16
2-7-4 Operation of the setting menu, inputting of characters .....	17
3 Functions related to the operation .....	19
3-1 Hierarchy of functions related to the operation .....	19
3-2 Unit setting .....	20
3-3 Percent scale function .....	20
3-4 Adding function.....	21
3-4-1 Weighing by means of the plus side addition .....	22
3-4-2 Weighing by means of the minus side addition .....	23
3-5 Comparator function.....	24
3-5-1 How to perform discrimination .....	24
3-5-2 Discrimination criteria, and upper and lower limits setting .....	24
3-5-3 Comparator function setting.....	25
3-6 Buzzer setting.....	26
3-7 Bar graph indication .....	26
3-8 Conditions for stability waiting .....	27
3-9 Tare weight value storage function .....	27
3-10 Direct start.....	28
3-11 Auto power-off .....	28
4 Function srelated to the performance.....	29
4-1 Hierarchy of functions related to the performance.....	29
4-2 Zero tracking .....	30





4-3	Stability discrimination width .....	30
4-4	Stability discrimination frequency .....	31
4-5	Response speed .....	31
4-6	Weight renewal interval .....	32
5	User information setting .....	33
5-1	Hierarchy of user information setting .....	33
5-2	Measurer's ID setting .....	33
5-3	Product name ID setting .....	34
5-4	Lot number setting .....	34
5-5	Code number setting .....	34
5-6	Preset tare weight setting .....	35
5-6-1	Inputting of a preset tare weight value .....	35
5-6-2	Registration of a preset tare weight value .....	37
5-6-3	Calling of a preset tare weight value .....	37
5-7	Setting of a percent scale reference value .....	38
5-8	Setting of the discrimination value of the comparator function .....	39
5-8-1	Numeric value setting method .....	39
5-8-2	Actual value setting method .....	42
5-9	Coefficient value setting .....	45
6	External input/output functions .....	46
6-1	Hierarchy of the external input/output functions .....	46
6-2	Connector terminal numbers and their functions .....	47
6-3	FZ communication format (CRC provided) .....	47
6-4	GZIII format .....	47
6-4-1	Basic communication specification .....	47
6-4-2	Basic data output format .....	48
6-4-3	Meaning of the data .....	48
6-4-4	Input command composition .....	49
6-4-5	Transmission procedure .....	49
6-4-6	Command format .....	50
6-5	GZII format .....	51
6-5-1	Command format .....	51
6-6	Response .....	52
6-6-1	Response command format (when set to the A00, Exx format) .....	52
6-6-2	Response command .....	52
6-6-3	Response command format (when set to the ACK, NAK format) .....	52
6-6-4	Response command .....	52
6-7	External contact input (tare weight subtraction / zero adjustment / tare weight subtraction & zero adjustment) .....	52
6-8	Power supply box communication setting .....	53
6-9	Maintenance setting .....	55
7	Functions related to the lock .....	56
7-1	Hierarchy of functions related to the lock .....	56
7-2	Locking of functions related to the operation .....	56
7-3	Key lock function .....	57
7-4	Total lock release .....	57
8	Controlling and adjustment functions .....	58
8-1	Hierarchy of controlling and adjustment functions .....	58
8-2	Outputting of the span adjustment result .....	59

8-3	Span adjustment history .....	59
8-4	Scale ID setting .....	60
8-5	Maintenance setting .....	60
8-6	Date and time setting .....	61
8-7	Date indication format .....	61
8-8	Output character setting .....	61
8-9	Password control.....	62
8-10	Password change.....	62
8-11	Password cancellation history .....	63
8-12	Operation of minimum weight indication .....	64
8-13	Minimum weight indication value setting .....	64
8-14	Designation of minimum indication.....	65
8-15	Reset to the factory settings.....	67
8-16	Span adjustment .....	67
8-17	Setting for maintenance .....	70
9	Execution menu .....	71
9-1	Operation of the execution menu .....	71
9-2	Calling of the registered user information .....	72
9-3	Registration of user information.....	73
9-4	Calling of device setting information.....	74
9-5	Storage of device setting information .....	74
9-6	Printing of the GLP header .....	75
9-7	Printing of the GLP footer.....	75
9-8	Program number and check sum indication .....	76
9-9	Outputting of weight data.....	77
9-9-1	Outputting of tare weight.....	77
9-9-2	Outputting of gross weight .....	77
9-9-3	Outputting of accumulated value. ....	78
9-10	Indication of minimum weighed value .....	78
10	Troubleshooting .....	79
10-1	Error messages .....	79
10-2	Troubleshooting.....	82
10-3	Maintenance method.....	82
Appendix	.....	83
Appendix 1	Specification .....	83
Appendix 1-1	Connectable scales.....	83
Appendix 1-2	Functional specification.....	84
Appendix 1-3	Dimensional outline drawing .....	85
Appendix 2	Operation of the setting menu .....	86
Appendix 3	Setting menu hierarchy list .....	88
Appendix 4	Print sample.....	93
Index of Terms.....		95

# 1 Prior to use

## 1-1 Precautions

### DANGER

	<p>■ <b>No disassembling or modification.</b> Unless specifically stated in this document, disassembling or modification of this product, mounting or removal of an undesignated component no longer maintains the function of the explosion-proof structure, leading to a serious accident or bodily injury.</p>
	<p>■ <b>Install the power supply box in “non dangerous location.”</b> Use of the power supply box in a dangerous place will cause trouble such as an explosion or a fire.</p>
	<p>■ <b>Connect the grounding terminal and cables properly.</b> Improper connection of the grounding terminal and cables will cause trouble such as an explosion or a fire.</p>
	<p>■ <b>Do not replace fuse, optional slots of the power supply box or access to the AC power terminal when the AC power cord is connected to the mains power.</b> That may cause an electric shock, short-circuiting or failure. Make sure disconnect from the AC mains or shut down the AC mains before accessing to those parts.</p>
	<p>■ <b>Do not connect the cables with its connector or jack being wet.</b> That may cause an electric shock, short-circuiting or failure.</p>
	<p>■ <b>Do not wet the power supply box.</b> That may cause an electric shock, short-circuiting or failure.</p>
	<p>■ <b>Do not open the AC connector cover unless the power supply box is installed as a built-in unit on a distribution board or other enclosure of which access is permitted to the trained and authorised persons only.</b> That may cause an electric shock, short-circuiting or failure.</p>

### WARNING

	<p>■ <b>Do not move the device with a sample to be weighed set on the scale.</b> That may cause the sample to fall from the weighing pan, leading to a bodily injury or destruction of the sample.</p>
	<p>■ <b>Do not connect to the main unit the power supply cord, scale cable, or communication cable with its connector or jack being wet.</b> That may cause an electric shock, short-circuiting or failure.</p>
	<p>■ <b>Do not use the product on an unstable table or a place that is subject to vibration.</b> That may cause the article to fall from the weighing pan, leading to a bodily injury or destruction of the article. Besides inaccurate weighing may result.</p>
	<p>■ <b>Do not move the scale holding its windshield.</b> That may cause the scale itself to fall, leading to a bodily injury or malfunction of the scale itself. Be sure to hold the main unit of the scale to move it.</p>
	<p>■ <b>Do not place an unstable sample on the weighing pan.</b> The sample may fall down and cause injury. Put an unstable sample in a container (tare) before weighing it.</p>

	<p>■ <b>Do not use the product in an abnormal condition.</b> If it should happen that an abnormal event such as smoking or unusual odor occurs, ask the store where you purchased the product for repair. Keeping using the product may result in an electric shock or fire. In addition, do not ever try to repair it for yourself, or very dangerous situation is likely to occur.</p>
	<p>■ <b>Do not touch the electrode with a wet or dirty hand.</b> Otherwise, an electric shock or short-circuiting may result.</p>

**CAUTION**

	<p>■ <b>Avoid miswiring of the barrier.</b> Erroneous barrier wiring in the power supply box is likely to cause failure.</p>
	<p>■ <b>Do not give a shock to the scale.</b> It may cause breakage or failure. Place a sample to be weighed softly.</p>
	<p>■ <b>Do not let an overload situation (o-Err indication) continue.</b> It may cause breakage or failure. Remove the sample to be weighed immediately.</p>
	<p>■ <b>Do not use volatile solvent.</b> Use of volatile solvent is likely to deform the main unit. Dirt on the main unit should be removed with a piece of dry cloth or cloth wet with small amount of neutral detergent.</p>

**Note**

	<p>■ <b>Do not use the product where wind from an HVAC equipment directly applies.</b> Accurate weighing may be impeded due to the fluctuation of surrounding temperature.</p>
	<p>■ <b>Do not use the product where there is direct sun.</b> Accurate weighing may be impeded due to the rise of internal temperature.</p>
	<p>■ <b>Do not use the product where floor is soft.</b> Accurate weighing may be impeded due to the tilting of the main unit when an object is placed on it.</p>
	<p>■ <b>Do not use the product where there is violent fluctuation of surrounding temperature or humidity.</b> Accurate weighing may possibly be impeded. Use within a temperature range of 5 to 40 °C and below a humidity of 85% RH.</p>
	<p>■ <b>Do not use the product on an unstable table or a place that is subject to vibration.</b> It may cause not only inaccurate weighing but also the sample to fall from the weighing pan, leading to a bodily injury.</p>
	<p>■ <b>Be sure to make adjustment at the time of installation or changing a use place.</b> There occurs an error in measurement value. For the sake of accurate measurement, be sure to make adjustment.</p>
	<p>■ <b>Check for an error periodically.</b> Use environment and chronological change cause an error in measured value, leading to an inaccurate measurement.</p>
	<p>■ <b>Align the level of the scale without fail before use.</b> Weighing with a slanted scale causes an error, leading to an inaccurate measurement. Put the scale on a robust place.</p>

**1-2 Names and functions of each section**

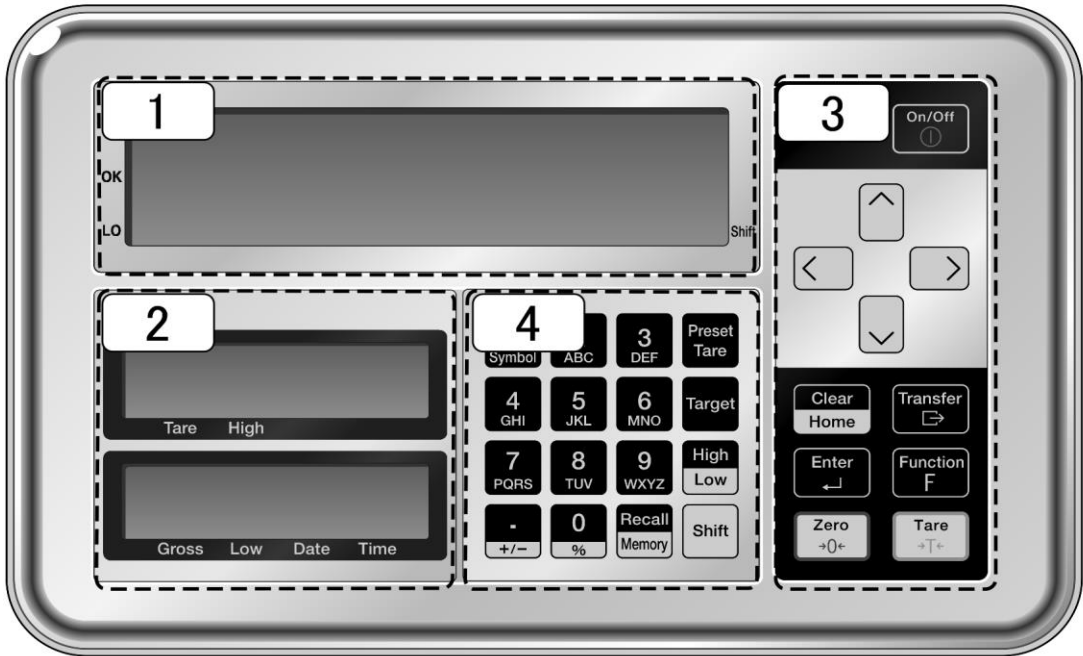

- 1 Main LCD
- 2 Sub LCDs ( i03 only)
- 3 Main keys
- 4 Numeric keypad

**1-3 Performance of operation keys**

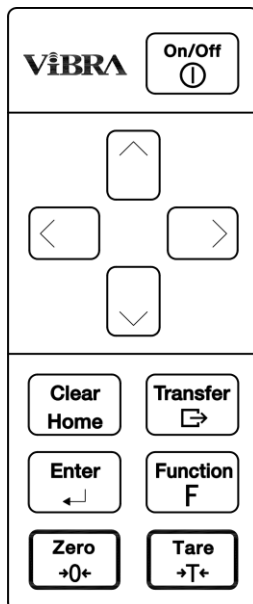
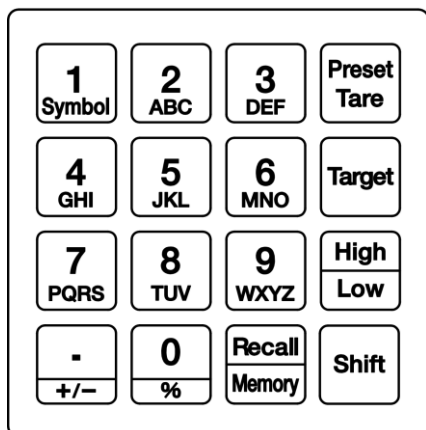

No.	Type / name of a key	Performance
1	[On / Off]	Turns on and off the power for the scale.
2	[Direction]	Used for function setting.
3	[Transfer]	Used for outputting.
4	[Function F]	Used for function calling.
5	[Tare]	Used for tare weight subtraction.
6	[Clear Home]	Used for cancelling the setting.
7	[Enter]	Used for finalizing various setting values.
8	[Zero]	Used for zero adjustment.
9	[Preset tare]	Used for setting preset tare weight value.
10	[Target]	Used for setting the reference value for comparator function.
11	[High / Low]	Used for setting the upper and lower limit values for comparator function.
12	[Shift]	Used for inputting the key function indicated in red.
13	[Recall / Memory]	Used for registering or calling the preset tare weight value or user information.
14	[Numeric keypad]	Used for inputting a numeric value or setting an ID.

**1-4 How to interpret the display**

**1-4-1 Main LCD**



No.	Symbol	Name	Description
1	<b>g</b>	Gram	Represents gram unit.
2	<b>kg</b>	Kilogram	Represents kilogram unit.
3	<b>%</b>	Percent	Lights when in the percent scale mode.
4	<b>→0←</b>	Zero point	Indicates the zero point.
5	<b>+</b>	Plus	Plus
6	<b>-</b>	Minus	Minus
7	<b>▶ Lower right</b>	Shift	Represents that the [Shift] key was pushed.
8	<b>Net</b>	Tare weight subtraction	Indicates that the tare weight is being subtracted.
9	<b>PT</b>	Preset tare weight	Indicates the preset tare weight.
10	<b>○</b>	Stable indication	When illuminated: The scale is in the stable condition. When not illuminated: The scale is not in the stable condition.
11	<b>*</b>	Addition available	- Lights in the standby status. - Addition available status when the adding function is used.
12	<b>M</b>	Memory access	- Flashes when the scale is in the process of stabilization. - Lights when writing in the memory.
13	<b>Σ</b>	Accumulated values	Lights when various accumulated values are being indicated.
14	<b>8.</b>	7-segment display	Displays numbers and simple letters.
15	<b>⇨</b>	Data output	Lights when data are being output to external devices.
16	<b>◀</b>	Discrimination result	Lights when indicating the discrimination result (HI/OK/LO) of the operation of the comparator function.
17	<b>CAL</b>	Span calibration/adjustment	Lights at the time of span calibration and adjustment.
18	<b>▬▬▬▬▬▬▬▬</b>	Bar graph	Indicates the present total amount relative to the weighing capacity defined as 100%.
19	<b>#</b>	Coefficient scale	Lights when the coefficient scale is effective.
20	<b>UC</b>	Weighing accuracy Unguaranteed indication	Lights when accuracy guarantee is difficult due to the condition of span adjustment.

**1-4-2 Sub LCDs ( i03 only)**

■Upper sub LCD

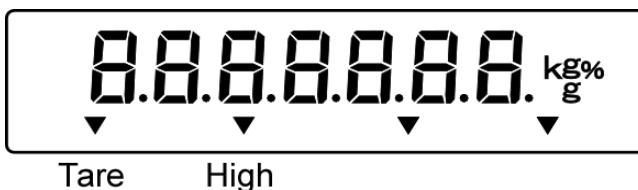

■Lower sub LCD

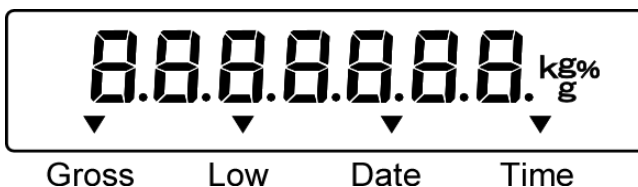

No	Symbol	Name	Description
1	<b>g</b>	Gram	Represents gram unit.
2	<b>kg</b>	Kilogram	Represents kilogram unit.
3	<b>%</b>	Percent	Lights when in the percent scale mode.
4	<b>8.</b>	7-segment display	Displays numbers and simple letters.
5	<b>—</b>	Minus	Minus
6	<b>▼</b>	Arrow	Represents tare weight / upper limit / total amount / lower limit / date / time.

**1-4-3 LCD character font**





# 2 Basic usage

## 2-1 Turning on / off the power, and checking for the operation

Turn on and off the power for this product.

**1** Turn on the power.

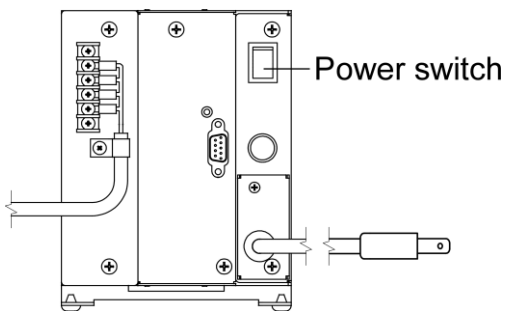

Turn on the power for the power supply box.

An asterisk ( \* ) mark lights on the main LCD, and the product becomes standby status.

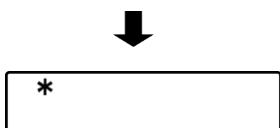

**Reference**

Setting the direct start function to "ON" shifts to the state of weighing automatically.

**2** Turn on the power for the scale.

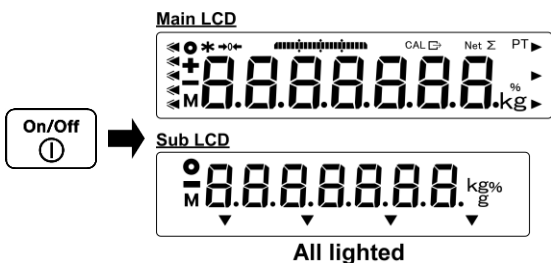

Push the [On/Off] key.

All displays on the main and sub LCDs light, followed by the self-check of the scale. During the self-check, the LCD displays automatically change.



Completion of the self-check is followed by the weight scale mode.

**CAUTION**

Do not push any key during the self-check.

The sub LCD is installed only on the i03.

**3** Scale operation check

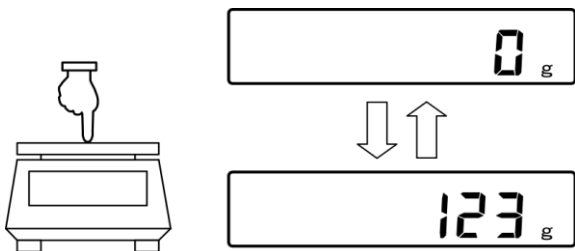

Press the weighing pan lightly to check if the indication changes.

**4** Turn off the power for the scale.

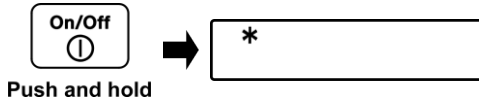

Push and hold the [On/Off] key.  
The product becomes standby status and the symbol ( \* ) lights.

**Reference**  
Pushing and holding the [On/Off] key obtains the standby status from any operation status.

**2-2 Making a zero adjustment**

Adjusting the indication to zero is called “zero adjustment.”

**1** Check the top of the weighing pan.

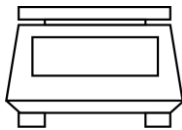

Make sure that nothing is placed on the top of the weighing pan.

**2** Make a zero adjustment.

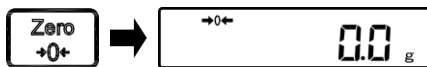

Push the [Zero] key.

Displays on the main LCD become zero and the symbol “ →0← ” lights.

<p><b>Reference</b></p>	<p>(1) It might be possible that the “Zero adjustment” cannot not be performed when an object is placed on the weighing pan. In that case, make the “tare weight subtraction” referring to the “Weighing an object placed on a container (tare)”</p> <p>(2) Stability waiting during the zero adjustment can be set using the function item “Stability waiting.” In the case the “Stability waiting” is set, the symbol “M” flashes during the stability waiting. For its setting method, refer to “3 Functions related to the operation.”</p>
<p><b>Legal Metrology</b></p>	<p>(1) “Stability waiting” setting function of the above (2) can not be use.</p>

**2-2-1 Zero adjustment range when in use**

Zero adjustment range when in use is limited in this product.

The available zero adjustment range when in use is shown below:

Model	Lower limit (g)	Upper limit (g)
FZ623Ex	-9.3	9.3
FZ3202Ex	-48	48
FZ6202Ex	-93	93
FZ15001Ex	-225	225
FZ30K0.1GEx	-450	450
FZ60K0.1GEx	-900	900
FZ100K1GEx	-1500	1500
FZ200K1GEx	-3000	3000
FZ150K1GFEx	-2250	2250
FZ300K1GFEx	-4500	4500

## 2-3 Weighing an object placed on a container (tare)

When weighing an object to be weighed with the object placed on a container (tare), the weight of the container must be subtracted from the total weight to get the actual weight of the object to be weighed. This is called “tare weight subtraction.”

**1** Place a container on the weighing pan.

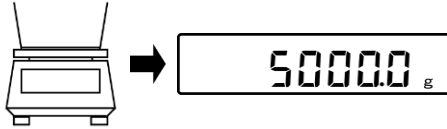

The weight of the container is displayed.

**2** Perform the tare weight subtraction.

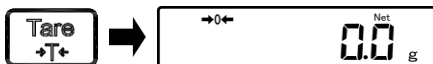

Push the [Tare] key.

The indication changes to zero and the “Net” symbol lights.

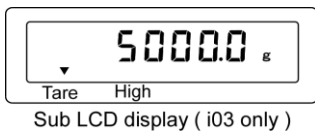

The indication changes to zero and the “**Net**” symbol lights.

**3** Place an object to be weighed on the container.

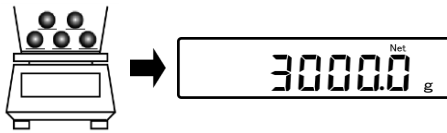

The net weight of the object to be weighed alone is indicated.

**4** Clear the tare weight.

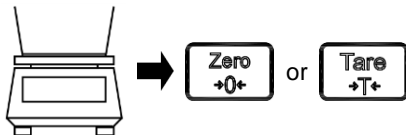

Remove the tare and the object to be weighed from the weighing pan.

[Push the [Zero] key or the [Tare] key.]



The indication changes to zero and the “**Net**” symbol goes out.

Reference	<p>(1) Performing the tare weight subtraction narrows the weighing range as much as the amount of the tare weight mass (tare weight). Weighable range = weighing capacity - tare weight</p> <p>(2) Stability waiting during the tare weight subtraction can be set using the function item “Stability waiting.” In the case the “Stability waiting” is set, the symbol “M” flashes during the stability waiting. For its setting method, refer to “3 Functions related to the operation”.</p> <p>(3) When using a tare whose tare weight is already known, the tare weight subtraction can be performed in advance by inputting its tare weight (preset tare weight subtraction). For its setting method, refer to “5 User information setting”.</p> <p>(4) When turning on the power placing a tare that exceeds the zero adjustment range at the time of power supply, the tare weight subtraction is executed.</p>
Legal Metrology	<p>(1) Operation of the above (4) is not performed.</p>

**2-4 Weighing with an object to be weighed added**

Place an added object to be weighed and weigh the weight of the added object.  
 Performing the tare weight subtraction with the object to be weighed which has been already weighed makes it possible to weigh the mass of a next object to be weighed with the previous object to be weighed remaining placed.

**1** Place an object to be weighed.

The mass of the object to be weighed placed is indicated.

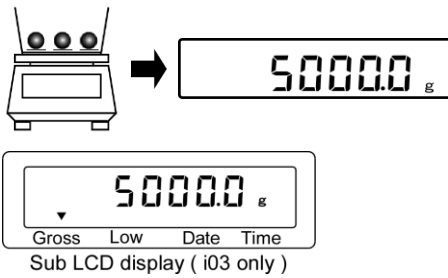

**2** Perform the tare weight subtraction.

Push the [Tare] key.

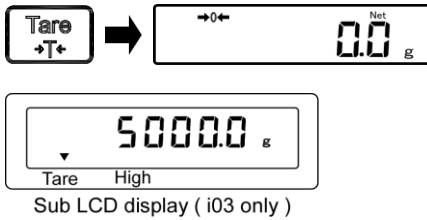

The indication changes to zero and the "Net" symbol lights.

The indication changes to zero and the " **Net** " symbol lights.

**3** Place an additional object to be weighed.

The mass of the added object alone is indicated.

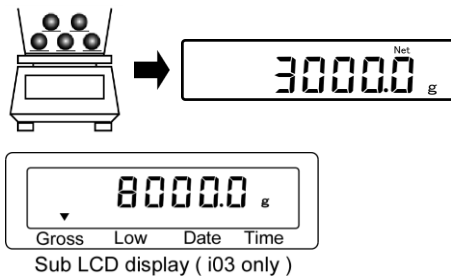

## 2-5 Selecting the main LCD indication

The main LCD and the sub LCD can be used in combination with each other.  
 The content of main LCD indication changes in the following sequence:

**Reference** In the case the percent scale function and the adding function are set, selection (switching) of the main LCD indication is available. (Refer to “3 Functions related to the operation”.)

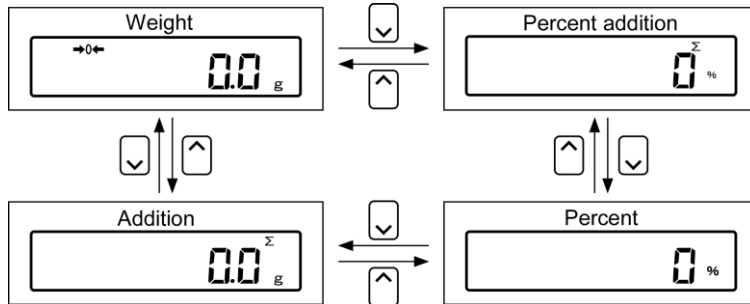

## 2-6 Selecting the sub LCD indication ( i03 only)

The main LCD and the sub LCD can be used in combination with each other.  
 The content of main LCD indication changes in the following sequence:

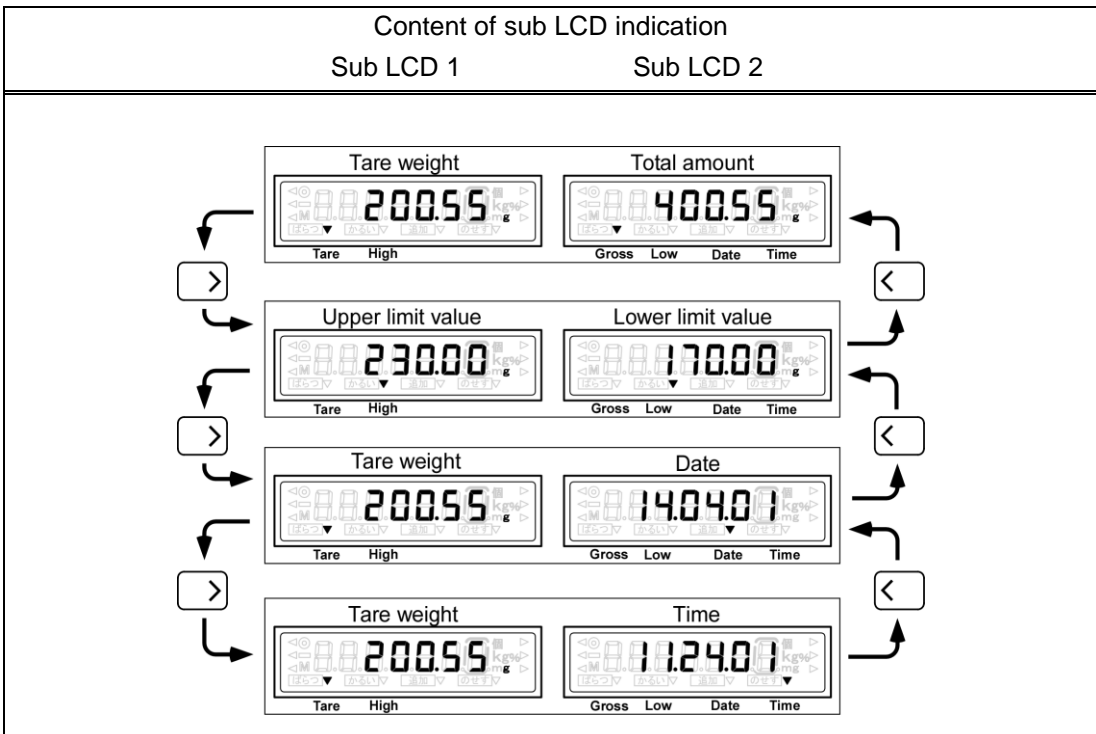

**Reference** When power is turned off, the previous indication is maintained.  
 Example) Power is turned off when the tare weight and the time are indicated.  
 The next time power is turned on, the LCD indication appears with the tare weight and the time being displayed.

## 2-7 Basic operation

The menu of this product is divided into two as described below:

(1) Setting menu

The menu to set a variety of functions

(2) Execution menu

The menu not to set but only to execute the program.

### 2-7-1 Hierarchy of a setting menu

The setting menu of this product is divided into four, from the first layer to the third layer and for various settings.

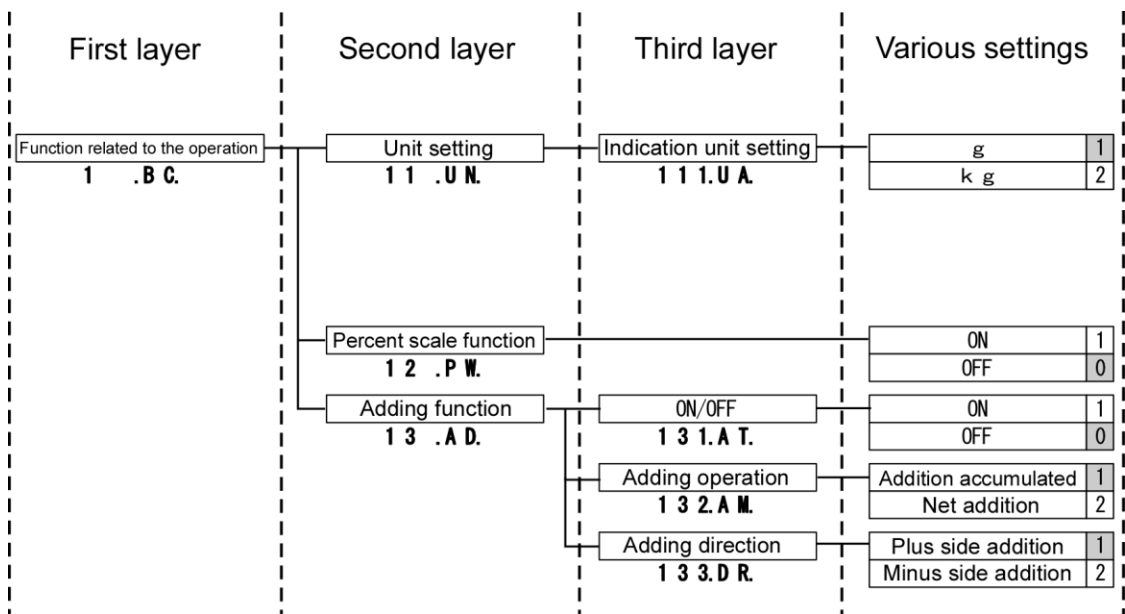

## 2-7-2 Operation of the setting menu, setting of various functions

To perform settings for various functions from the state of weighing, chiefly execute the following procedure.

- (1) Push [Function F] key to enter respective setting from the state of weighing.
- (2) Shift to the intended setting item using the [Direction] key.
- (3) Change the setting value using the [Enter] and [Direction] key.

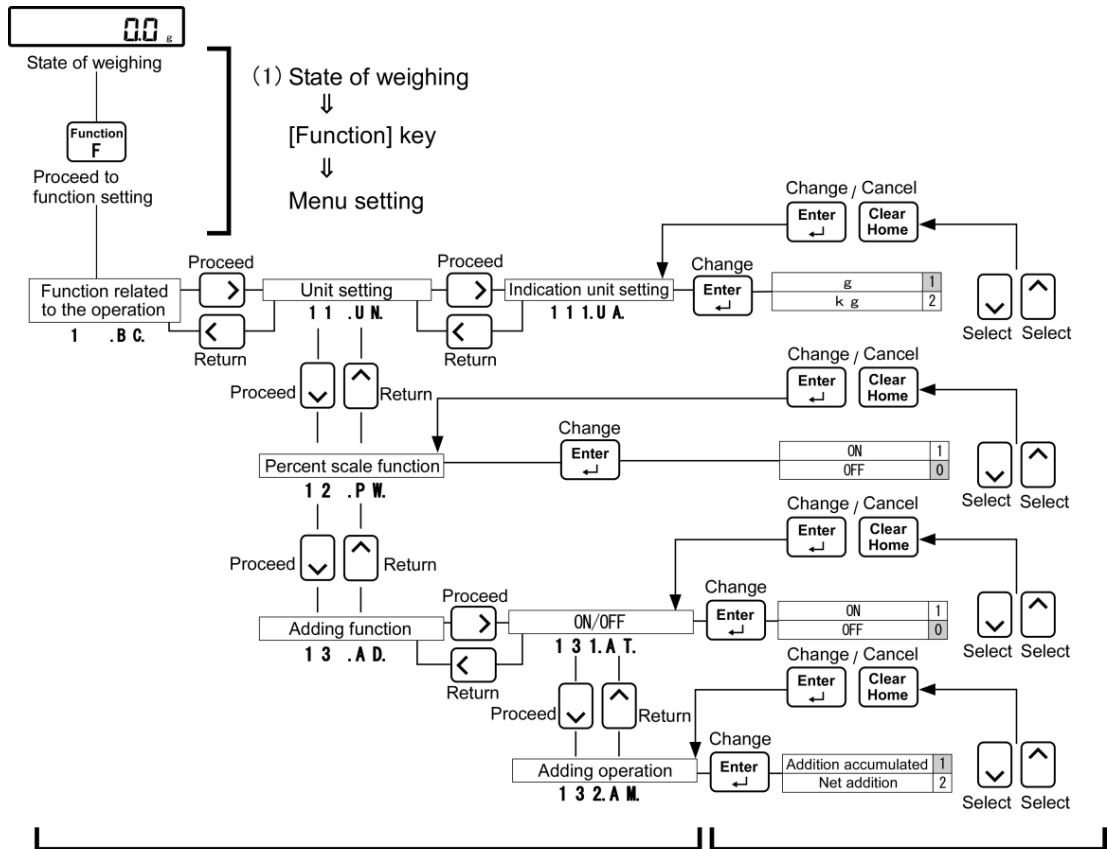

(2) [Direction] key ⇒ Shift to the intended setting item.

(3) [Enter] and [Direction] keys ⇒ Change the setting value.



To return to the state of weighing after setting various functions, chiefly execute the following procedure.

(1) Push the [Shift] and then [Clear Home] keys at any of the first, second or third layer.

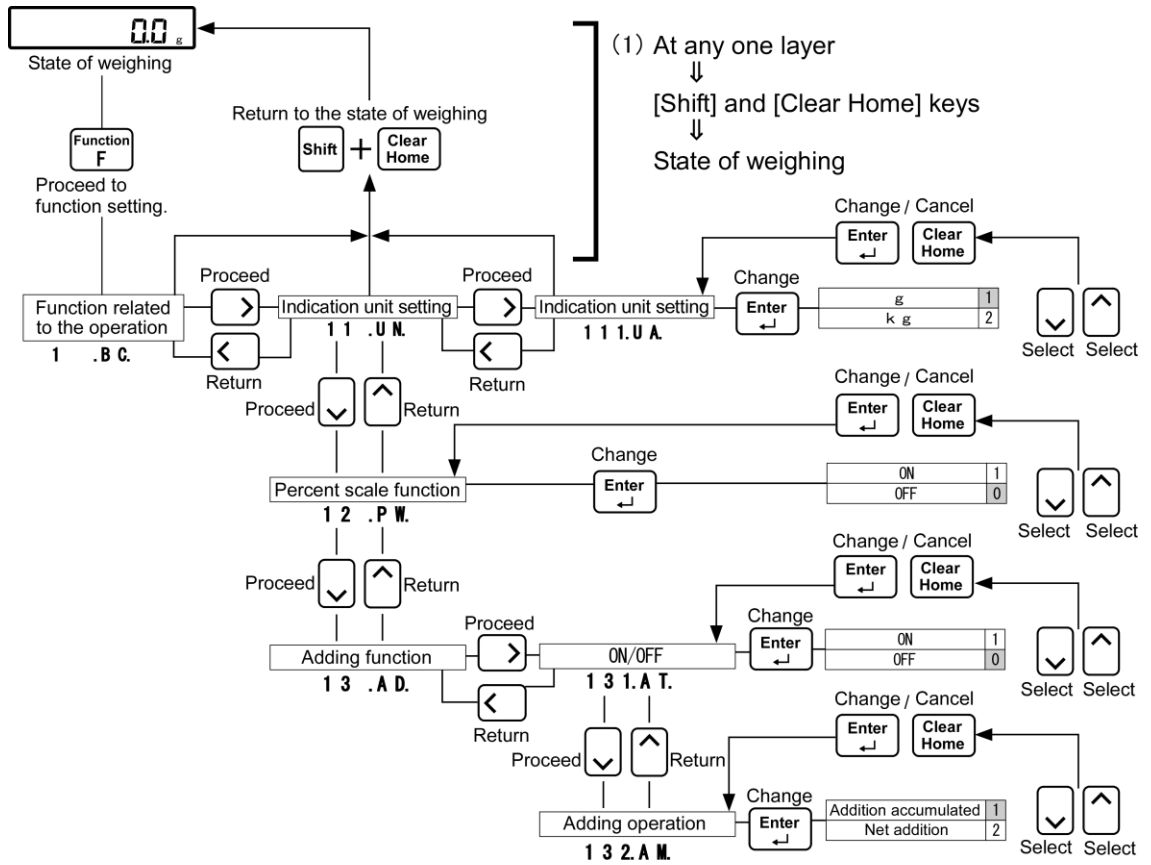

**2-7-3 Operation of the setting menu, inputting of numeric values**

Reference	Numeric value inputting is limited to seven digits at a maximum.
-----------	--

■Example) When inputting 12345

1 Input "1".

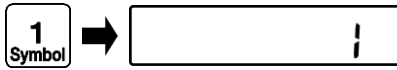

Push the [Numeric keypad] "1."  
Number "1" is displayed on the extreme right like 「 1」.

2 Input "2".

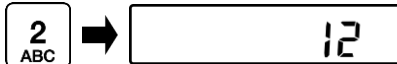

Push the [Numeric keypad] "2."  
Number "12" is displayed on the extreme right like 「 12」 with the previously input "1" moving to the left.

3 Input "3", "4" and "5" in sequence.

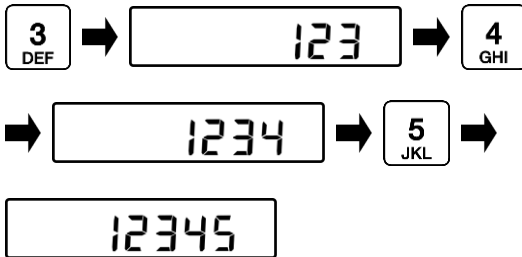

Push the [Numeric keypad] "3", "4" and "5" in sequence.

4 Fix the numeric values that have been input.

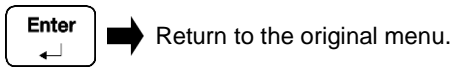

Push the [Enter] key.  
Return to the original menu

5 When inputting a numeric value with a minus symbol (-) attached



Push the [Shift] key and then [· (+/-)] keys in sequence.  
Input a numeric value referring to step 1 to 4 above.

Reference	Before pushing the [Enter] key, pushing the [Clear Home] key enables you to input a numeric value again.
-----------	--

**2-7-4 Operation of the setting menu, inputting of characters**

■ Operation of character input

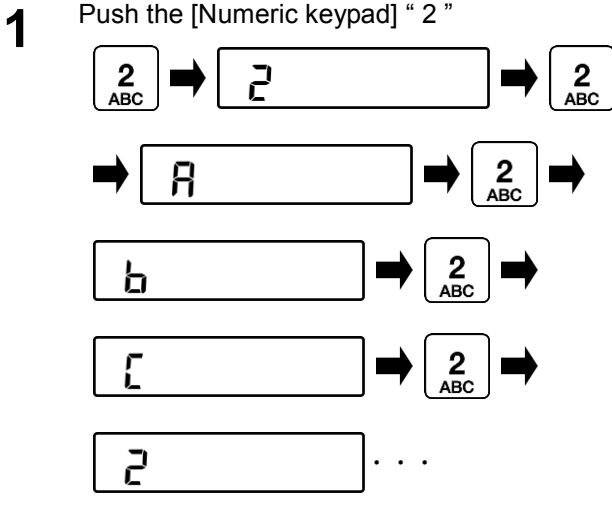

Push the [Numeric keypad] “2” .  
 Number “2” is displayed on the extreme left like 「2       」 .

Push the [Numeric keypad] “2” again.  
 Letter “A” is displayed on the extreme left like 「A       」 .  
 After that, every time the [Numeric keypad] “2” is pushed, the letter changes to “B” then “C.”

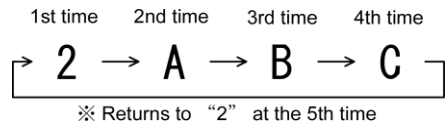

■ Example) When inputting ABC

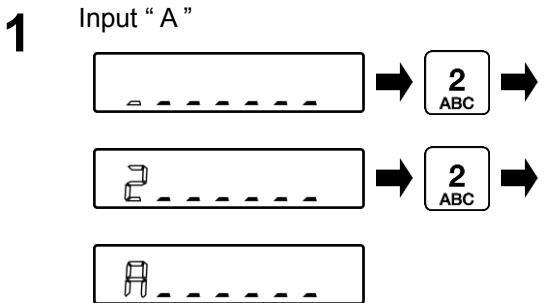

Push the [Numeric keypad] “2” .  
 Number “2” is displayed on the extreme left like 「2       」 .

Push the [Numeric keypad] “2” again.  
 Letter “A” is displayed on the extreme left like 「A       」 .

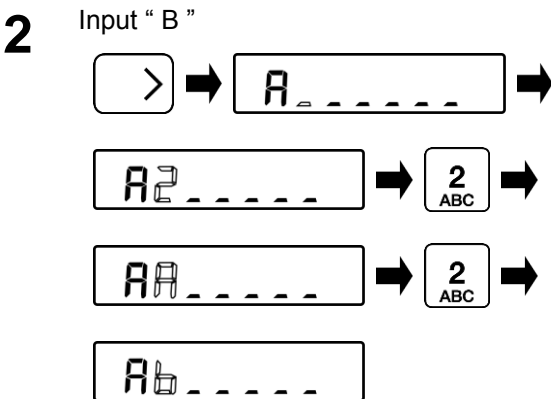

[Push “Right ” of the [Direction] key.  
 The digit that has been input moves to the right.

Keep pushing the [Numeric keypad] “2” till the indication changes to

**3**

Input "C"

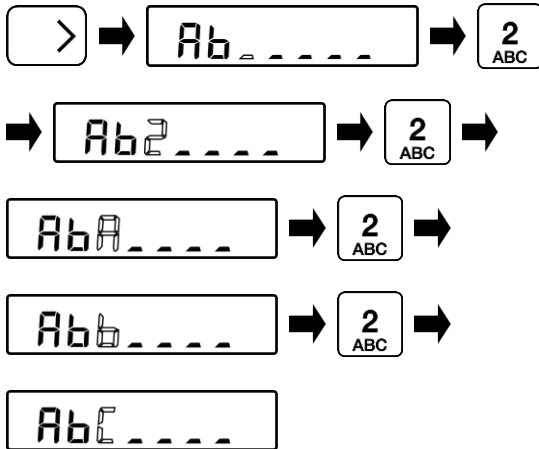

Push "Right" of the [Direction] key.

The digit that has been input moves to the right.

Keep pushing the [Numeric keypad] "2" till the indication changes to "「ABC」".

**4**

Discontinue inputting.

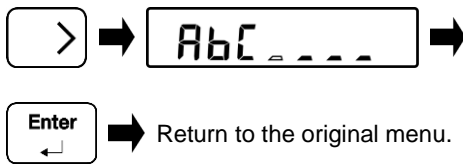

Push "Right" of the [Direction] key.

The digit that has been input moves to the right.

Push the [Enter] key.

Character inputting completes, return to the original menu indication.

Reference	<p>Each push of the <b>1 Symbol</b> changes the indication as shown below:</p> <div style="text-align: center;"> <p>1st time      2nd time      3rd time</p> <p>※ Returns to "1" at the 4th time</p> </div>
-----------	---

# 3 Functions related to the operation

Settings to change the scale operations

## 3-1 Hierarchy of functions related to the operation

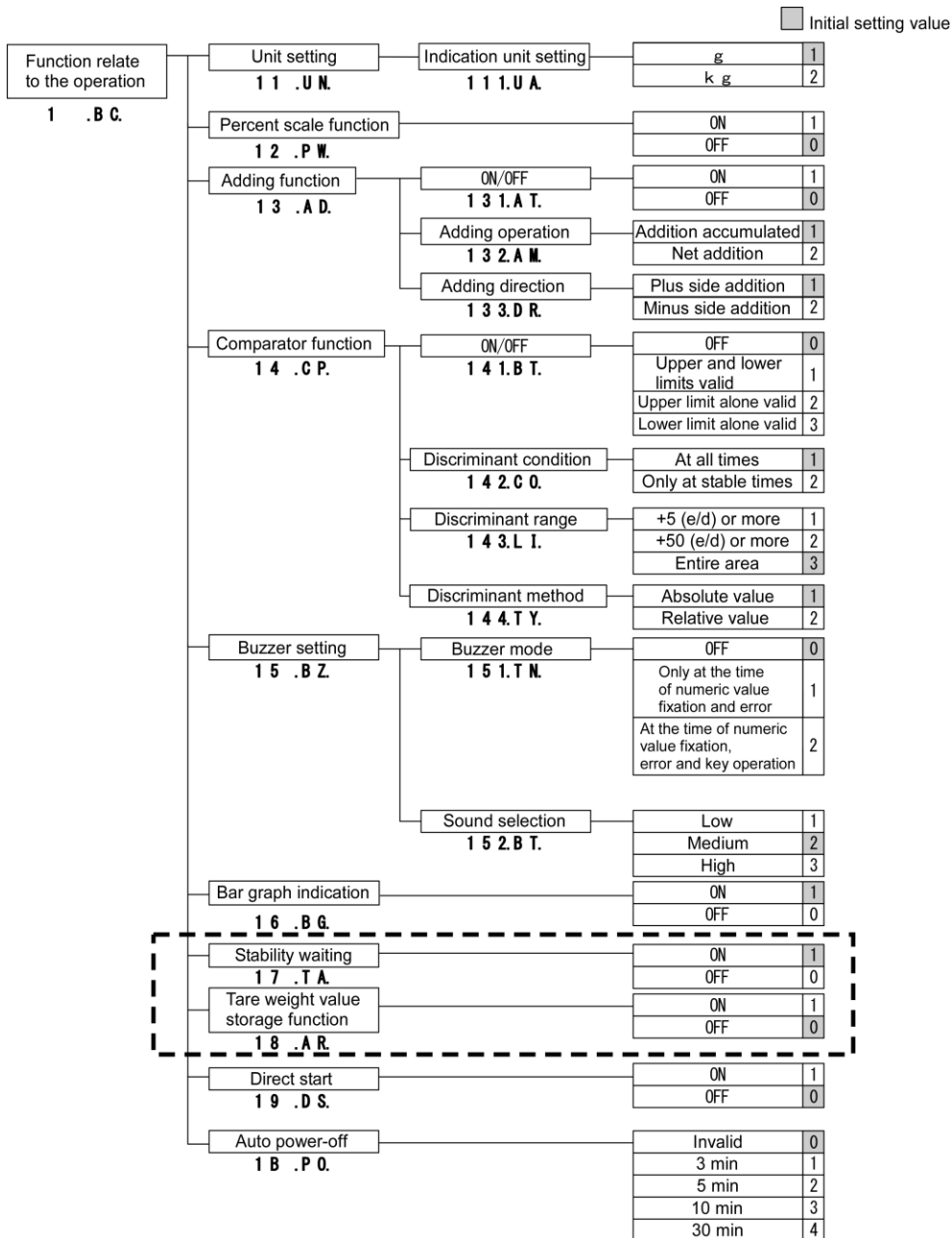

” [ ] “ can not be used.

### 3-2 Unit setting

Unit in the weight mode can be set either in 「g」 or 「kg」.

- 1 Select a setting menu.  
Select the unit setting.  
(“2-7-2 Operation of the setting menu, setting of various functions” and “3-1 Hierarchy of functions related to the operation”)

- 2 Decide the unit.



Inputting of the setting value

- 3 Finish the unit setting.



Push the [Direction] key.

Select 「111.UA.」.

Input a setting value.

「111.UA. 1」 : g

「111.UA. 2」 : kg

Push the [Shift] and then the [Clear Home] keys.

The operation mode changes to the weight scale mode and the unit that has been set is indicated.

Legal  
Metrology

Unit that can be used to the model of Max 100kg-300Kg is only “111.UA.2:kg”.

### 3-3 Percent scale function

The weight of an object to be weighed is indicated in percent relative to the reference weight.

- 1 Select a setting menu.  
Select the percent scale.  
(“2-7-2 Operation of the setting menu, setting of various functions” and “3-1 Hierarchy of functions related to the operation”)

- 2 Set the operation mode to the percent scale mode.

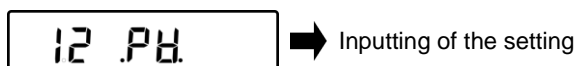

value

- 3 Finish the setting.

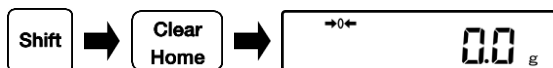

- 4 Switch the indication mode to the percent scale mode.

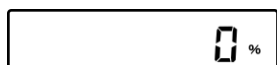

Push the [Direction] key.

Select 「12.PW.」

Input a setting value.

「12.PW. 1」 : ON

「12.PW. 0」 : OFF

Push the [Shift] and then the [Clear Home] keys.

The operation mode returns to the weight scale mode.

Push “Up” or “Down” of the [Direction] key.

「 % 」 appears on the indicator, showing that the operation mode has been changed to the percent scale mode.

**3-4 Adding function**

Weighs a plurality of objects to be weighed in sequence and indicates its total value.  
The adding function includes two ways of calculating method.

Addition accumulating function	Method of weighing objects to be weighed while replacing the objects
Net adding function	Method of weighing objects to be weighed without replacing the objects

The adding function can be used in any scale mode, i.e. weight scale mode, percent scale mode, and coefficient scale mode.

**1** Select a setting menu.  
Select the adding function.  
(“2-7-2 Operation of the setting menu, setting of various functions” and “3-1 Hierarchy of functions related to the operation”)

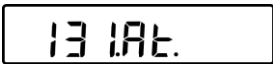
**2** Set the adding function.  
 →  
Inputting of the setting value



Push the [Direction] key.  
Select 「131.AT.」 .  
Input a setting value.  
「131.AT. 0」 : OFF  
「131.AT. 1」 : ON

**3** Select the addition accumulating function or the net adding function.  
 →  
Inputting of the setting value



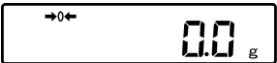

Push the [Direction] key.  
Select 「132.AM.」 .  
Input a setting value.  
「132.AM. 1」 : Addition accumulated  
「132.AM. 2」 : Net addition

**4** Select either the plus side addition or the minus side addition.  
 →  
Inputting of the setting value

Push the [Direction] key.  
Select 「133.DR.」 .  
Input a setting value.  
「133.DR. 1」 : Plus side addition  
「133.DR. 2」 : Minus side addition

**5** Finish the setting.  
 →  → 

Push the [Shift] and then the [Clear Home] keys.  
The operation mode returns to the weight scale mode.

**6** Switch the indication to the addition mode.  
 →  or  →  

Push “Up” or “Down” of the [Direction] key.  
「Σ」 appears on the indicator, showing that the operation mode has been changed to the addition mode.

**3-4-1 Weighing by means of the plus side addition**

**1** Place a first object to be weighed.

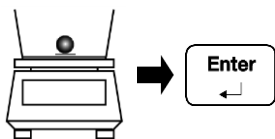

After 「 \* 」 appears, push [Enter] key.  
The weighed value is stored and 「 Σ 」 is indicated for a few seconds.

**2** In the case of the addition accumulating  
Replace an object to be weighed with a new one.

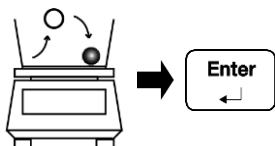

Remove the previous object to be weighed to return the indication to zero and then place a next object to be weighed.  
After 「 \* 」 appears, push [Enter] key.  
The weighed value is stored and 「 Σ 」 is indicated for a few seconds.  
Repeat this operation to perform addition.

**3** In the case of the net addition  
Add an object to be weighed.

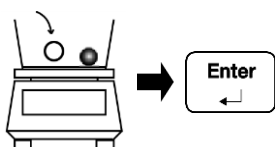

Add an object to be weighed without doing any other operation.  
After 「 \* 」 appears, push [Enter] key.  
After indicating 「 Σ 」 and the accumulated value for a few seconds, the scale returns to the weight indication, followed by the automatic tare weight subtraction.  
Repeat this operation to perform addition.

**4** Indicate the accumulated value.

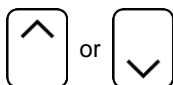

Push the [Direction] key.  
「 Σ 」 and the accumulated value are indicated.

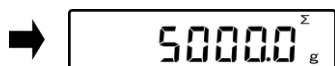

**5** Clear the accumulated value.

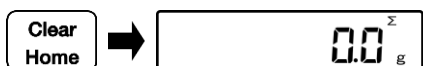

Push the [Clear Home] key.  
The accumulated value is cleared.



**3-4-2 Weighing by means of the minus side addition**

**1** Place an object to be weighed and perform the tare weight subtraction.

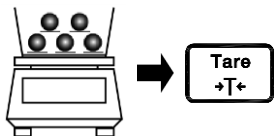

After 「 Tare 」 appears, push [Enter] key.

The weighed value is stored and 「  $\Sigma$  」 is indicated for a few seconds.

**2** Remove the object to be weighed and perform adding calculation.

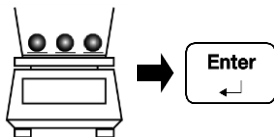

Remove the object to be weighed. After 「 \* 」 appears, push [Enter] key.

The weighed value is stored and 「  $\Sigma$  」 is indicated for a few seconds. Repeat this operation to perform addition.

**3** Remove a next object to be weighed and perform adding calculation.

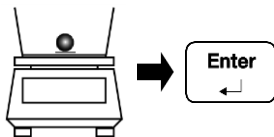

Remove the object to be weighed without doing any other operation. After 「 \* 」 appears, push [Enter] key.

After indicating 「  $\Sigma$  」 and the accumulated value for a few seconds, the scale returns to the weight indication, followed by the automatic tare weight subtraction. Repeat this operation to perform addition.

**4** Indicate the accumulated value.

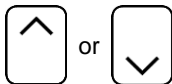

Push the [Direction] key.

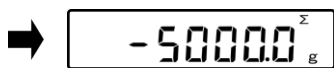

「  $\Sigma$  」 and the accumulated value are indicated.

**5** Clear the accumulated value.



Push the [Clear Home] key.

The accumulated value is cleared.

### 3-5 Comparator function

It is possible to preset threshold values and determine whether or not a measured value is within the range defined by the preset values.

Reference	The comparator function can be used in any scale mode, i.e. weight scale mode, percent scale mode, and coefficient scale mode.
-----------	--

#### 3-5-1 How to perform discrimination

Set the lower and the upper limits. Then, whether or not the weight of an object to be weighed is low (lower than the lower limit), appropriate or high (higher than the upper limit) is indicated on the main LCD with 「◀」.

Single point (lower limit) setting			Single point (upper limit) setting			Two-point (upper and lower limits) setting		
Over the upper limit	Appropriate amount	Below the lower limit	Over the upper limit	Appropriate amount	Below the lower limit	Over the upper limit	Appropriate amount	Below the lower limit
HI OK LO <	HI OK LO <	HI OK LO ◀	HI < OK LO	HI < OK LO	HI ◀ OK LO	HI ◀ OK < LO <	HI < OK ◀ LO <	HI < OK < LO ◀

#### 3-5-2 Discrimination criteria, and upper and lower limits setting

The discrimination is performed according to the following criteria:

Absolute value	The discrimination is performed based on the upper and lower limit values that have been set in advance.
Relative value	A reference numeric value is set in advance, and the discrimination is performed based on the range defined by the upper and lower limit values that have been set for the reference numeric value.

**3-5-3 Comparator function setting**

**1** Select a setting menu.  
 Select comparator function.  
 (“2-7-2 Operation of the setting menu, setting of various functions” and “3-1 Hierarchy of functions related to the operation”)

**2** Set comparator function.

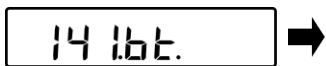

Inputting of the setting value

Push the [Direction] key.

Select 「141.BT.」 .

Input a setting value.

「141.BT.0」 : OFF

「141.BT.1」 : Upper and lower limits valid

「141.BT.2」 : Upper limit alone valid

「141.BT.3」 : Lower limit alone valid

**3** Set discriminant conditions.



Inputting of the setting value

Push the [Direction] key to select

「142.CO.」

Input setting values

「142.CO.1」 : Discrimination at all times

「142.CO.2」 : Discrimination only at

stable times

**4** Set a discriminant range.

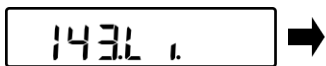

Inputting of the setting value

Push the [Direction] key.

Select 「143.LI.」

Input a setting value.

「143.LI.1」 : More than 5d

「143.LI.2」 : More than 50d

「143.LI.3」 : Entire area

**5** Set a discriminant method.

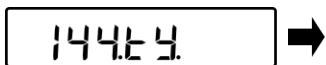

Inputting of the setting value

Push the [Direction] key.

Select 「144.TY.」

Input a setting value.

「144.TY.1」 : Absolute value discrimination

「144.TY.2」 : Deviation value discrimination

Reference	For the setting of the reference value and upper and lower limit values, refer to “5 User information setting”.
-----------	---

**3-6 Buzzer setting**

This is a convenient function for key inputting and use of the comparator function.

- 1** Select a setting menu.  
Select the buzzer setting function.  
("2-7-2 Operation of the setting menu, setting of various functions" and "3-1 Hierarchy of functions related to the operation")

- 2** Select the buzzer mode setting.

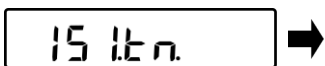

Inputting of the setting value

Push the [Direction] key.  
Select 「151.TN.」  
Input a setting value.

「151.TN.0」 :	OFF
「151.TN.1」 :	At the time of -numeric value fixation/error.
「151.TN.2」 :	At the time of -numeric value fixation/error. -key input/error. -keypad operation.

- 3** Select the buzzer tone setting.



Inputting of the setting value

Push the [Direction] key.  
Select 「152.BT.」  
Input a setting value.

「152.BT.1」 :	Low
「152.BT.2」 :	Medium
「153.BT.3」 :	High

**3-7 Bar graph indication**

Set the indication / non-indication of the bar graph.

- 1** Select a setting menu.  
Select the bar graph indication.  
("2-7-2 Operation of the setting menu, setting of various functions" and "3-1 Hierarchy of functions related to the operation")

- 2** Set the bar graph indication.

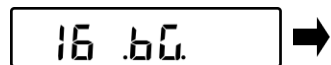

Inputting of the setting value

Push the [Direction] key.  
Select 「16.BG.」 .  
Input a setting value.

「16.BG.0」 :	OFF
「16.BG.1」 :	ON

### 3-8 Conditions for stability waiting

Legal Metrology	Can not be used.
--------------------	------------------

Set when to indicate the weighed value after the zero adjustment or tare weight subtraction; either after or before the weighed value stabilizes.

- 1 Select a setting menu.  
 Select the conditions for stability waiting.  
 (“2-7-2 Operation of the setting menu, setting of various functions” and “3-1 Hierarchy of functions related to the operation”)

- 2 Set the conditions for stability waiting.

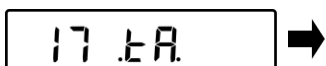

Inputting of the setting value

Push the [Direction] key.  
 Select 「17.TA.」  
 Input a setting value.  
 「17.TA.0」 : OFF  
 「17.TA.1」 : ON

### 3-9 Tare weight value storage function

Legal Metrology	Can not be used.
--------------------	------------------

The tare weight subtraction is performed with the mass stored at the time of power supply. This function is used when turning on and off the power with a tare and an object to be weighed placed on the weighing pan.

- 1 Select a setting menu.  
 Select the tare weight value storage function.  
 (“2-7-2 Operation of the setting menu, setting of various functions” and “3-1 Hierarchy of functions related to the operation”)

- 2 Set the tare weight value storage function.

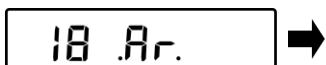

Inputting of the setting value

Push the [Direction] key.  
 Select 「18.AR.」 .  
 Input a setting value.  
 「18.AR.0」 : OFF  
 「18.AR.1」 : ON

### 3-10 Direct start

Setting to the direct start makes it possible to turn on and off the power with the switch on the power supply box without pushing the [On/Off] key.

- 1 Select a setting menu.  
Select the direct start function  
(“2-7-2 Operation of the setting menu, setting of various functions” and “3-1 Hierarchy of functions related to the operation”)

- 2 Set the direct start function.

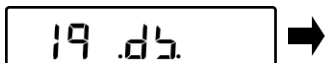

Inputting of the setting value

Push the [Direction] key.

Select 「19.DS.」

Input a setting value.

「19.DS.0」 : OFF

「19.DS.1」 : ON

### 3-11 Auto power-off

This function is to automatically turn off the power for the main unit.

- 1 Select a setting menu.  
Select the auto power-off function.  
(“2-7-2 Operation of the setting menu, setting of various functions” and “3-1 Hierarchy of functions related to the operation”)

- 2 Set the auto power-off function.

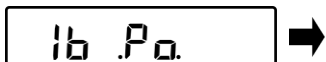

Inputting of the setting value

Push the [Direction] key.

Select 「1B.PO.」

Input a setting value.

「1b.PO.0」 : Invalid

「1b.PO.1」 : 3 min

「1b.PO.2」 : 5 min

「1b.PO.3」 : 10 min

「1b.PO.4」 : 30 min

# 4 Function srelated to the performance

Set the scale indication stability and response speed.

## 4-1 Hierarchy of functions related to the performance

Initial setting value

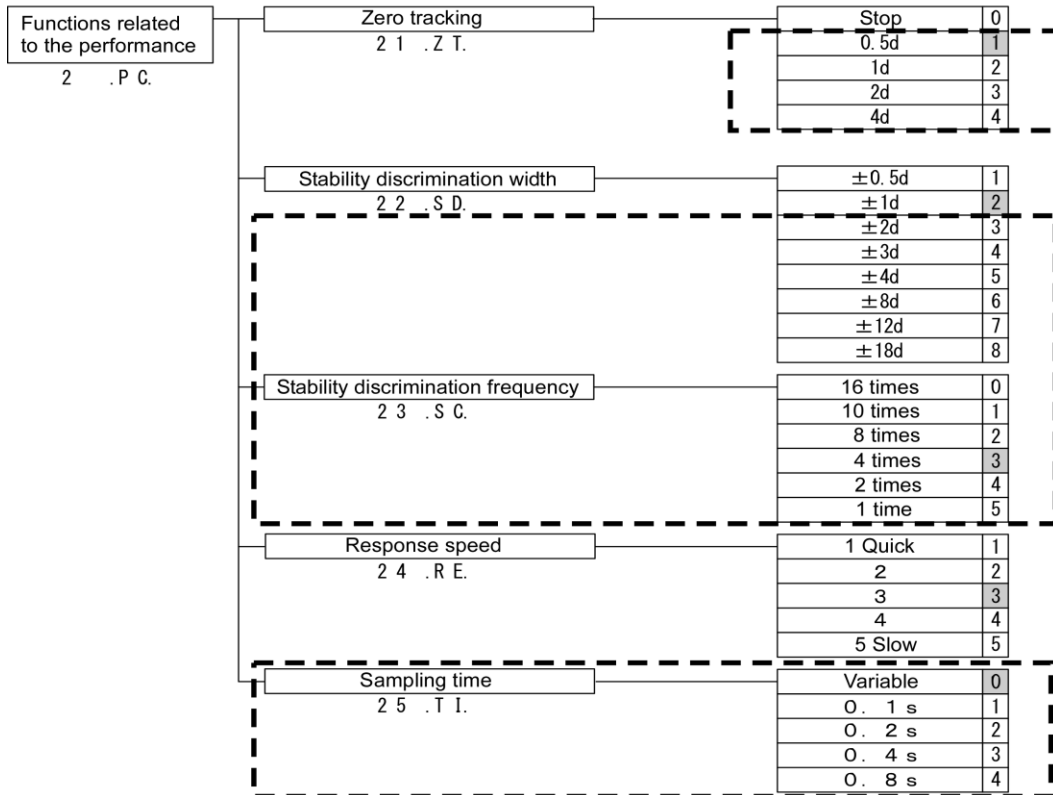

Legal  
Metrology

” [ - - - ] “ can not be used.

## 4-2 Zero tracking

Setting to the zero tracking function makes it possible to automatically correct the zero point fluctuation caused by the temperature fluctuation, etc. that is likely to occur when “0” is indicated, through which the “0” indication is maintained.

- 1 Select a setting menu.  
Select the zero tracking function.  
(“2-7-2 Operation of the setting menu, setting of various functions” and “4-1 Hierarchy of functions related to the performance”)

- 2 Set the zero tracking function.

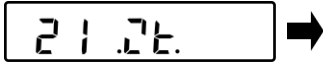

Inputting of the setting value

Push the [Direction] key.

Select 「21.ZT.」

Input a setting value.

「21.ZT.0」 : Stop

「21.ZT.1」 : 0.5d

「21.ZT.2」 : 1d

「21.ZT.3」 : 2d

「21.ZT.4」 : 4d

Legal  
Metrology

“21.ZT.2-4” can not be used.

## 4-3 Stability discrimination width

The larger numeric value is set, the higher stability is obtained.

- 1 Select a setting menu.  
Select the stability discrimination width.  
(“2-7-2 Operation of the setting menu, setting of various functions” and “4-1 Hierarchy of functions related to the performance”)

- 2 Set the stability discrimination width.

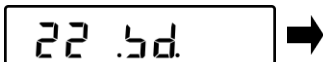

Inputting of the setting value

Push the [Direction] key.

Select 「22.SD.」

Input a setting value.

「22.SD.1」 : ±0.5d (Severe)

「22.SD.2」 : ±1d

「22.SD.3」 : ±2d

「22.SD.4」 : ±3d

「22.SD.5」 : ±4d

「22.SD.6」 : ±8d

「22.SD.7」 : ±12d

「22.SD.8」 : ±18d (Moderate)

Legal  
Metrology

“22.SD.3-8” can not be used.



**4-4 Stability discrimination frequency**

Legal  
Metrology

Can not be used.

The larger numeric value is set, the higher stability is obtained.

- 1** Select a setting menu.  
Select the stability discrimination frequency.  
("2-7-2 Operation of the setting menu, setting of various functions" and "4-1 Hierarchy of functions related to the performance")

- 2** Set the stability discrimination frequency.

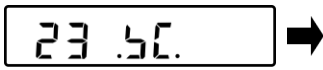

Inputting of the setting value

Push the [Direction] key.

Select 「23.SC.」 .

Input a setting value.

- 「23.SC.0」 : 16 times (Severe)
- 「23.SC.1」 : 10 times
- 「23.SC.2」 : 8 times
- 「23.SC.3」 : 4 times
- 「23.SC.4」 : 2 times
- 「23.SC.5」 : 1 times (Moderate)

**4-5 Response speed**

The larger numeric value is set, the higher stability is obtained.

- 1** Select a setting menu.  
Select the response speed.  
("2-7-2 Operation of the setting menu, setting of various functions" and "4-1 Hierarchy of functions related to the performance")

- 2** Set the response speed.

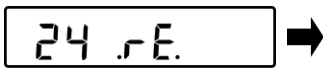

Inputting of the setting value

Push the [Direction] key.

Select 「24.RE.」

Input a setting value.

- 「24.RE.1」 : 1 (Quick)
- 「24.RE.2」 : 2
- 「24.RE.3」 : 3
- 「24.RE.4」 : 4
- 「24.RE.5」 : 5 (Slow)

## 4-6 Weight renewal interval

Legal  
Metrology

Can not be used.

This is a function to output data at regular intervals.

- 1 Select a setting menu.  
Select the sampling time.  
("2-7-2 Operation of the setting menu, setting of various functions" and "4-1 Hierarchy of functions related to the performance")

- 2 Set the sampling time.

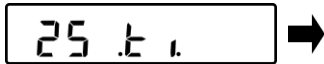

Inputting of the setting value

Push the [Direction] key.

Select 「25.TI.」 .

Input a setting value.

「25.TI.0」 : Variable

「25.TI.1」 : 0.1S

「25.TI.2」 : 0.2S

「25.TI.3」 : 0.4S

「25.TI.4」 : 0.8S

# 5 User information setting

Set various user IDs and upper and lower limit values.

## 5-1 Hierarchy of user information setting

Initial setting value

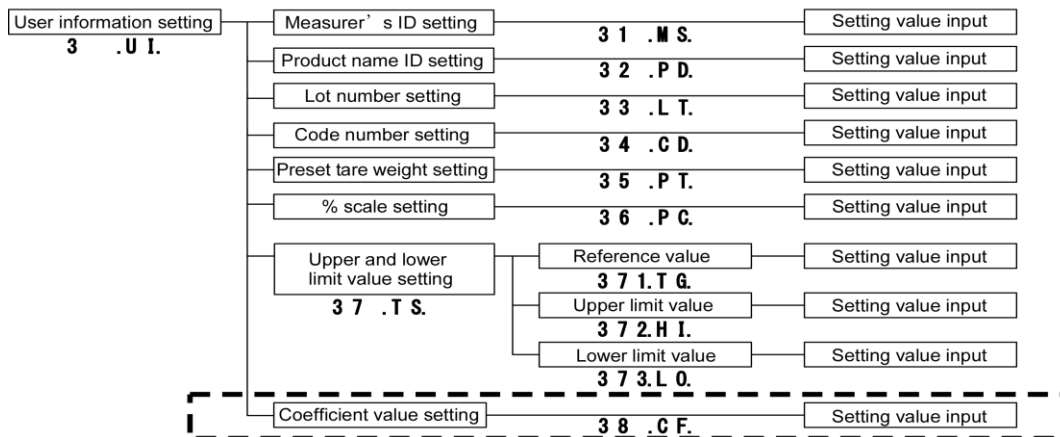

Reference	<p>(1) It is possible to register a number for an ID up to a maximum of ten digits.</p> <p>(2) Up to 100 IDs that have been set can be registered individually from “001” through “100”. For how to register, refer to “9 Execution menu.”</p> <p>(3) The characters that can be combined for use for an ID are as shown below: [Space (blank), 0 – 9, A – F, - (minus)] For the details of the character input, refer to “2-7-4 Operation of the setting menu, inputting of characters”.</p>
-----------	---

Legal Metrology	<p>” [ ] “ can not be used.</p>
-----------------	---------------------------------

## 5-2 Measurer's ID setting

An ID can be provided for each measurer.

- 1 Select a setting menu.  
Select the measurer's ID.  
("2-7-2 Operation of the setting menu, setting of various functions" and "5-1 Hierarchy of user information setting")

- 2 Set the measurer's ID.

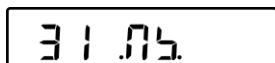

➡ Inputting of the ID

Push the [Direction] key.  
Select 「31.MS.」

("2-7-4 Operation of the setting menu, inputting of characters")

Input an ID.

### 5-3 Product name ID setting

An ID can be provided for each product name.

- 1 Select a setting menu.  
Select the product name ID.  
(“2-7-2 Operation of the setting menu, setting of various functions” and “5-1 Hierarchy of user information setting”)

- 2 Set the product name ID.

➡ Input an ID.

Push the [Direction] key.  
Select 「32.PD.」  
Input an ID.

(“2-7-4 Operation of the setting menu, inputting of characters”)

### 5-4 Lot number setting

A number can be provided for each lot.

- 1 Select a setting menu.  
Select the lot number.  
(“2-7-2 Operation of the setting menu, setting of various functions” and “5-1 Hierarchy of user information setting”)

- 2 Set the lot number.

➡ Input characters.

Push the [Direction] key.  
Select 「33.LT.」  
Input characters.

(“2-7-4 Operation of the setting menu, inputting of characters”)

### 5-5 Code number setting

A number can be provided for each code.

- 1 Select a setting menu.  
Select the code number.  
(“2-7-2 Operation of the setting menu, setting of various functions” and “5-1 Hierarchy of user information setting”)

- 2 Set the code number.

➡ Input characters.

Push the [Direction] key.  
Select 「34.CD.」

Input characters.

(“2-7-4 Operation of the setting menu, inputting of characters”)

## 5-6 Preset tare weight setting

Inputting, registration and calling of a preset tare weight value can be performed.

### 5-6-1 Inputting of a preset tare weight value

There are two ways of inputting a reference value and upper and lower limit values as described below:

- Numeric value setting method: Inputting a setting value directly via [Numeric keypad] operation
- Actual value setting method: Weighing a sample with a scale and then making it a setting value

- 1** Select a setting menu.  
 Select the preset tare weight setting.  
 ("2-7-2 Operation of the setting menu, setting of various functions" and "5-1 Hierarchy of user information setting")

- 2** Set the preset tare weight setting.



Push the [Direction] key.  
 Select 「35.PT.」

- 3** Set a tare weight value. [Numeric value setting method]

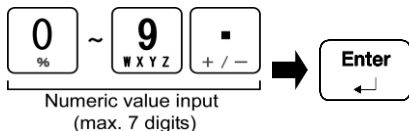

Input a tare weight value with the [Numeric keypad].  
 Push the [Enter] key.

The tare weight value is stored.

("2-7-3 Operation of the setting menu, inputting of numeric values")

- 3'** Set a tare weight value. [Actual value setting method]

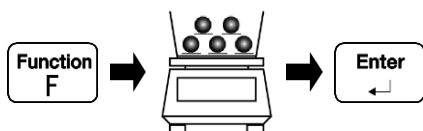

Push the [Function F] key.  
 Place an object to be weighed that is equivalent to the tare weight value.

Push the [Enter] key.  
 The tare weight value is stored.

- 4** The operation mode returns to the scale mode.

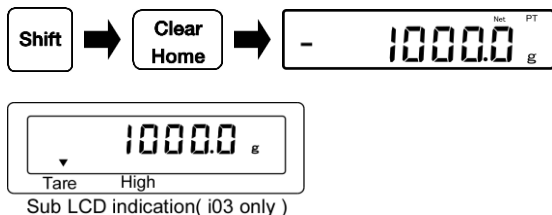

Return to the scale mode with the [Shift] and the [Clear Home] keys.

The preset tare weight value is indicated.  
 The tare weight is indicated on the sub LCD

- 5** To exit the preset tare weight subtraction mode

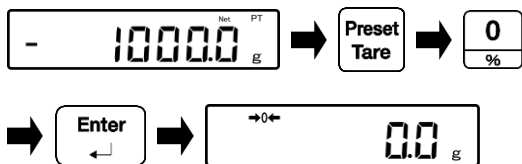

Push the [Preset tare] key.  
 Push [Numeric zero] key.  
 Push the [Enter] key.  
 Now the preset tare weight subtraction mode has exited.

**Reference** The preset tare weight setting can be performed out of the scale mode as a shortcut according to the following procedure:

**1** Set a tare weight value. [Numeric value setting method]

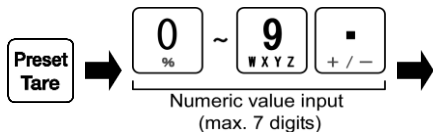

Sub LCD indication( i03 only )

(“2-7-3 Operation of the setting menu, inputting of numeric values”)

**1'** Set a tare weight value. [Actual value setting method]

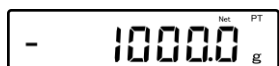
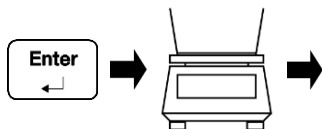
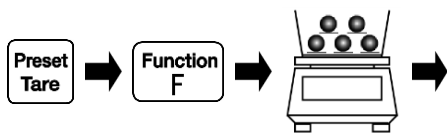

Sub LCD indication( i03 only )

**2** To exit the preset tare weight subtraction mode

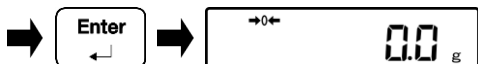
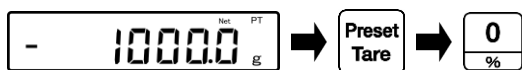

Push the [Preset tare] key in the scale mode.

Input a preset tare weight value with the [Numeric keypad].  
Push the [Enter] key.

The preset tare weight value is indicated.  
The tare weight is indicated on the sub LCD.

Push the [Preset tare] key in the scale mode.

Push the [Function F] key.  
Place an object to be weighed that is equivalent to the tare weight value.

Push the [Enter] key.  
Remove the object to be weighed.

The preset tare weight value is indicated.  
The tare weight is indicated on the sub LCD.

Push the [Preset tare] key.

Push [Numeric zero] key.

Push the [Enter] key.

Now the preset tare weight subtraction mode has exited.

### 5-6-2 Registration of a preset tare weight value

Nine preset tare weight values can be registered.

**1** Set a preset tare weight value.  
 (“2-7-2 Operation of the setting menu, setting of various functions” and “5-1 Hierarchy of user information setting”)

**2** Register the preset tare weight value.

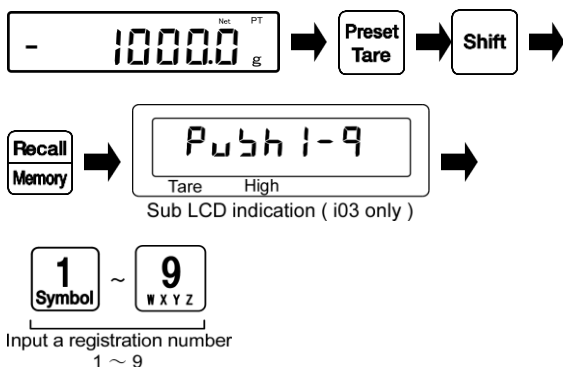

Push the [Preset tare] key.  
 Push the [Shift] and [Recall / Memory] keys.  
 An indication of “PUSH 1 - 9” appears on the sub LCD.

Input a registration number with [Numeric keypad].

### 5-6-3 Calling of a preset tare weight value

The registered preset tare weight value can be called.

**1** Call the preset tare weight value.

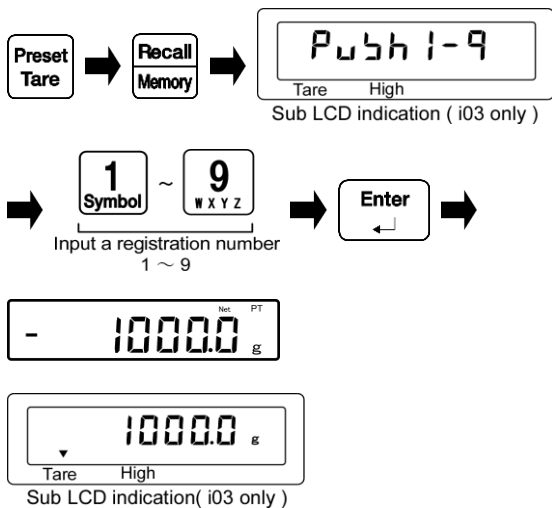

Push the [Preset tare] key.  
 Push the [Recall / Memory] key.

An indication of “PUSH 1 - 9” appears on the sub LCD.

Input a call number with [Numeric keypad].  
 Push the [Enter] key.

The preset tare weight value is indicated.  
 The tare weight is indicated on the sub LCD.

**5-7 Setting of a percent scale reference value**

The weight of an object to be weighed is indicated in percent relative to the reference weight. Set the reference weight by way of either the numeric value setting method, which requires the inputting of a numeric value, or the actual value setting method, which requires the weighing of a sample.

**1** Select a setting menu.  
 Select the percent scale.  
 (“2-7-2 Operation of the setting menu, setting of various functions”)

**2** Set the operation mode to the percent scale mode.  
 “3-3 Percent scale function”

**3** Set the reference value of the percent scale.

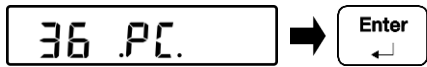

Push the [Direction] key.  
 Select “36.PT.”.

Push the [Enter] key.

**4** Set the reference value. [Numeric value setting method]

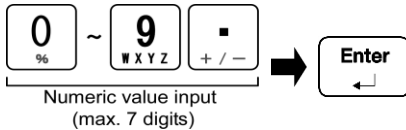

Input a reference value with the [Numeric keypad].

Push the [Enter] key.

The reference value is stored.

(“2-7-3 Operation of the setting menu, inputting of numeric values”)

**4'** Set the reference value. [Actual value setting method]

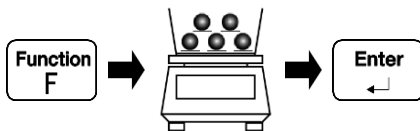

Push the [Function F] key.

Place an object to be weighed that is equivalent to the reference value.  
 Push the [Enter] key.

The reference value is stored

**5** The operation mode returns to the scale mode.

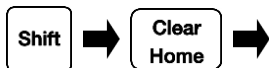

Returns to the scale mode with the [Shift] and the [Clear Home] keys.

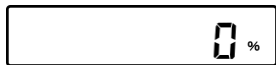

**6** The object is weighed.

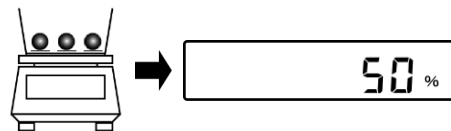

The weight of the object to be weighed is indicated in percent relative to the reference weight.

**7** Switch the main LCD.



Push the “Up” or “Down” of the [Direction] key.

The scale mode changes.

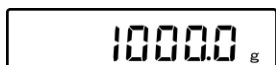



Reference	<p>An indication of "L-Err" signifies that the reference weight is below the limit weight and that the weight is unmeasurable.</p> <table border="1" style="margin: 20px auto; border-collapse: collapse;"> <thead> <tr> <th colspan="2" style="text-align: center;">Percent scale limit weight</th> </tr> </thead> <tbody> <tr> <td style="width: 60%;">FZ623Ex</td> <td style="text-align: center;">0.1 g</td> </tr> <tr> <td>FZ3202Ex、6202Ex</td> <td style="text-align: center;">1 g</td> </tr> <tr> <td>FZ15001Ex FZ30K0.1GEx、FZ60K0.1GEx</td> <td style="text-align: center;">10g</td> </tr> <tr> <td>FZ100K1GEx、FZ200K1GEx FZ150K1GFEx、FZ300K1GFEx</td> <td style="text-align: center;">100 g</td> </tr> </tbody> </table>	Percent scale limit weight		FZ623Ex	0.1 g	FZ3202Ex、6202Ex	1 g	FZ15001Ex FZ30K0.1GEx、FZ60K0.1GEx	10g	FZ100K1GEx、FZ200K1GEx FZ150K1GFEx、FZ300K1GFEx	100 g
Percent scale limit weight											
FZ623Ex	0.1 g										
FZ3202Ex、6202Ex	1 g										
FZ15001Ex FZ30K0.1GEx、FZ60K0.1GEx	10g										
FZ100K1GEx、FZ200K1GEx FZ150K1GFEx、FZ300K1GFEx	100 g										

### 5-8 Setting of the discrimination value of the comparator function

There are two ways of inputting a reference value and upper and lower limit values as described below:

- Numeric value setting method: Inputting a setting value directly via [Numeric keypad] operation
- Actual value setting method: Weighing a sample with a scale and then making it a setting value

#### 5-8-1 Numeric value setting method

**1** Select a setting menu.  
 Select the discrimination value setting of the comparator function.  
 ("2-7-2 Operation of the setting menu, setting of various functions")

**2** Select the reference value setting. (In the case of the relative value discrimination)

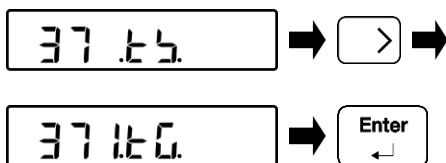

Push the [Direction] key.  
 Select "37.TS."  
 Push the [Direction] key.  
 Select "371.TG."

Push the [Enter] key.

**3** Set a reference value.

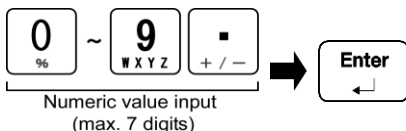

Input a reference value with the [Numeric keypad].  
 Push the [Enter] key.  
 The reference value is stored.

("2-7-3 Operation of the setting menu, inputting of numeric values")

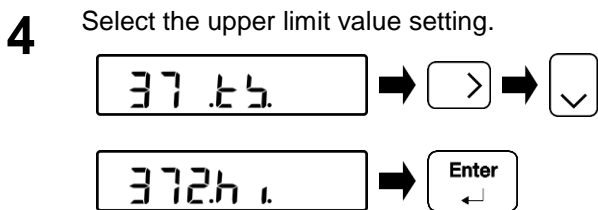

Push the [Direction] key.  
 Select “37.TS.”  
 Push the [Direction] key.  
 Select “372.HI.”  
 Push the [Enter] key.

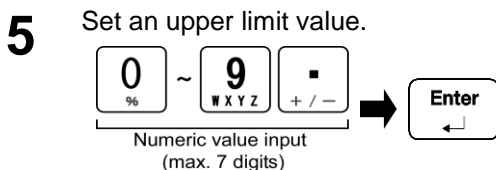

Input an upper limit value with [Numeric keypad].  
 Push the [Enter] key.

The upper limit value is stored.

(“2-7-3 Operation of the setting menu, inputting of numeric values”)

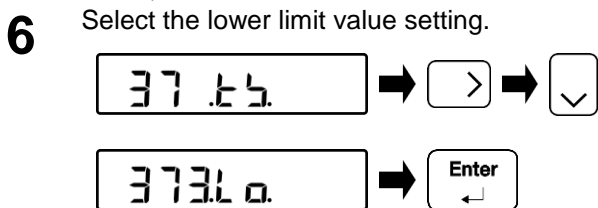

Push the [Direction] key.  
 Select “37.LO.”  
 Push the [Direction] key.  
 Select “373.LO.”  
 Push the [Enter] key.

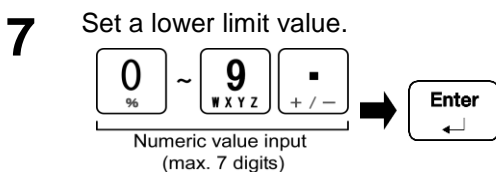

Input a lower limit value with [Numeric keypad].  
 Push the [Enter] key.

The lower limit value is stored.

(“2-7-3 Operation of the setting menu, inputting of numeric values”)

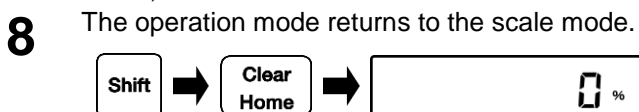

Returns to the scale mode with the [Shift] and the [Clear Home] keys.

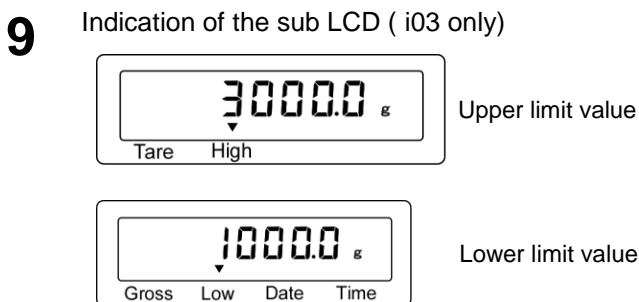

The upper and lower limit values that have been set are indicated on the sub LCD.

Reference	The discrimination value setting of the comparator function can be performed out of the scale mode as a shortcut according to the following procedure:
-----------	--

**1** Select the reference value setting. (In the case of the relative value discrimination)

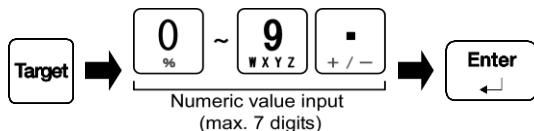

(“2-7-3 Operation of the setting menu, inputting of numeric values”)

Push the [Target] key in the scale mode.

Input a reference value with [Numeric keypad].

Push the [Enter] key.

The reference value is set.

**2** Set an upper limit value.

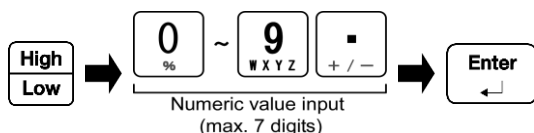

(“2-7-3 Operation of the setting menu, inputting of numeric values”)

Push the [High / Low] key in the scale mode.

Input an upper limit value with [Numeric keypad].

Push the [Enter] key.

The upper limit value is set.

**3** Set a lower limit value.

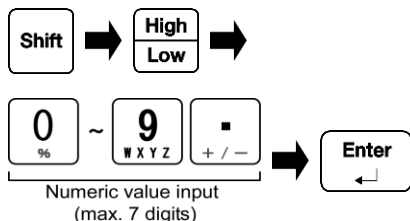

(“2-7-3 Operation of the setting menu, inputting of numeric values”)

Push the [Shift] key and the [High / Low] key in the scale mode.

Input a lower limit value with [Numeric keypad].

Push the [Enter] key.

The lower limit value is set.

**4** Indication of the sub LCD ( i03 only)

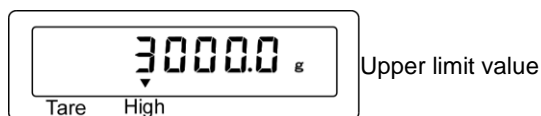

The upper and lower limit values that have been set are indicated on the sub LCD.

**5-8-2 Actual value setting method**

**1** Select a setting menu.  
 Select the discrimination value setting of the comparator function.  
 ("2-7-2 Operation of the setting menu, setting of various functions")

**2** Select the reference value setting. (In the case of the relative value discrimination)

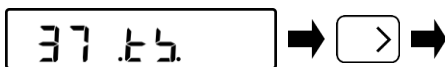

Push the [Direction] key.  
 Select "37.TS."

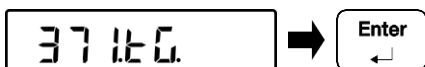

Push the [Direction] key.

Select "371.TG."  
 Push the [Enter] key.

**3** Set a reference value.

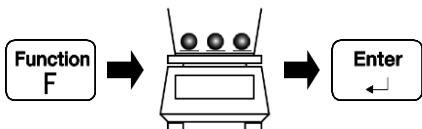

Push the [Function F] key.  
 Place an object to be weighed that is equivalent to the reference value.  
 Push the [Enter] key.  
 The reference value is stored.

**4** Select the upper limit value setting.



Push the [Direction] key.  
 Select "37.TS."

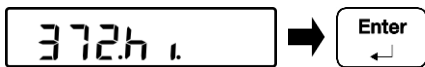

Push the [Direction] key.  
 Select "372.HI."  
 Push the [Enter] key.

**5** Set an upper limit value.

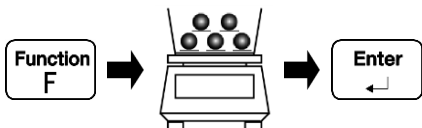

Push the [Function F] key.  
 Place an object to be weighed that is equivalent to the upper limit value.

Push the [Enter] key.  
 The reference value is stored.

**6** Select the lower limit value setting.



Push the [Direction] key.  
 Select "37.TS."

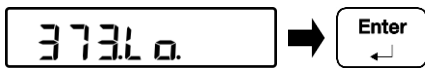

Push the [Direction] key.  
 Select "373.LO."  
 Push the [Enter] key.

## 7 Set a lower limit value.

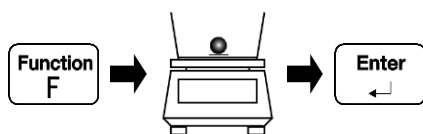

Push the [Function F] key.

Place an object to be weighed that is equivalent to the lower limit value.

Push the [Enter] key.

The lower limit value is stored.

## 8 The operation mode returns to the scale mode.



Returns to the scale mode with the

[Shift] and the [Clear Home] keys.

## 9 Indication of the sub LCD ( i03 only)



Upper limit value



Lower limit value

The upper and lower limit values that have been set are indicated on the sub LCD.

**Reference** The discrimination value setting of the comparator function can be performed out of the scale mode as a shortcut according to the following procedure:

**1** Select the reference value setting. (In the case of the relative value discrimination)

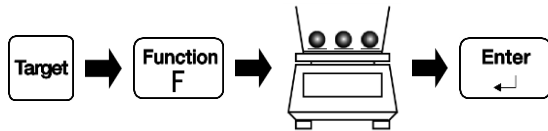

Push the [Target] key in the scale mode.

Push the [Function F] key.

Place an object to be weighed that is equivalent to the reference value.

Push the [Enter] key.

The reference value is stored.

**2** Set an upper limit value.

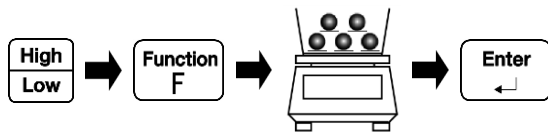

Push the [High / Low] key in the scale mode.

Push the [Function F] key.

Place an object to be weighed that is equivalent to the upper limit value.

Push the [Enter] key.

The reference value is stored.

**3** Set a lower limit value.

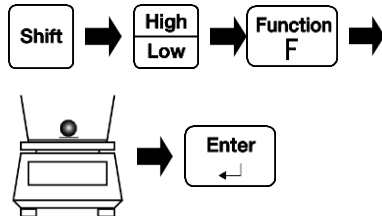

Push the [Shift] key and the [High / Low] key in the scale mode.

Push the [Function F] key.

Place an object to be weighed that is equivalent to the lower limit value.

Push the [Enter] key.

The lower limit value is stored.

**4** Indication of the sub LCD ( i03 only)

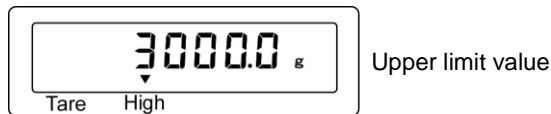

Upper limit value



Lower limit value

The upper and lower limit values that have been set are indicated on the sub LCD.

**Reference**

- (1) When the upper and lower limit values that were set have been found to be the other way around, three indicators on the main LCD will light. Re-set the upper and lower limit values.
- (2) Combination input, e.g. numeric value input for the upper limit value and actual value input for the lower limit value, is also available.
- (3) In the case the relative value discrimination is selected, input a difference value relative to the reference value.  
For example, when making a discrimination in the case the upper limit value = 3000 g, and the lower limit value = 1000 g:  
Make a setting at reference value = 2000 g, the upper limit value = 1000 g, and the lower limit value = -1000 g.

**5-9 Coefficient value setting**

<p>Legal Metrology</p>	<p>Can not be used.</p>
----------------------------	-------------------------

The value that is obtained by multiplying a measured weight by a predetermined coefficient can be indicated.

For example, in the case the coefficient is “2.35” and the measured weight is “2000 g”, a value of “4700 g” is indicated.

(Example) Object to be weighed (2000 g) × coefficient (2.35) → Indication (4700)

**1** Select a setting menu.  
 Select the coefficient scale.  
 (“2-7-2 Operation of the setting menu, setting of various functions”)

**2** Set the coefficient scale setting.



Push the [Direction] key.  
 Select “38.CF.”  
 Push the [Enter] key.

**3** Set a coefficient value.

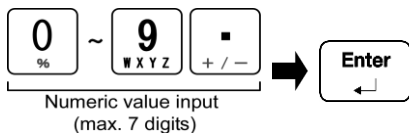

Input a coefficient value with the [Numeric keypad].  
 Push the [Enter] key.

(“2-7-3 Operation of the setting menu, inputting of numeric values”)

The coefficient value is stored.

**4** The operation mode returns to the scale mode.



Returns to the scale mode with the [Shift] and the [Clear Home] keys.

**5** The object is weighed.

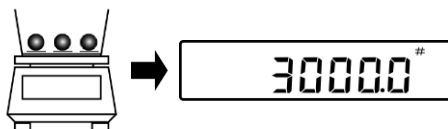

The value obtained by multiplying the measured weight by the predetermined coefficient is indicated.

# 6 External input/output functions

This function is used for communication through the external peripheral devices.

## 6-1 Hierarchy of the external input/output functions

■ Initial setting value

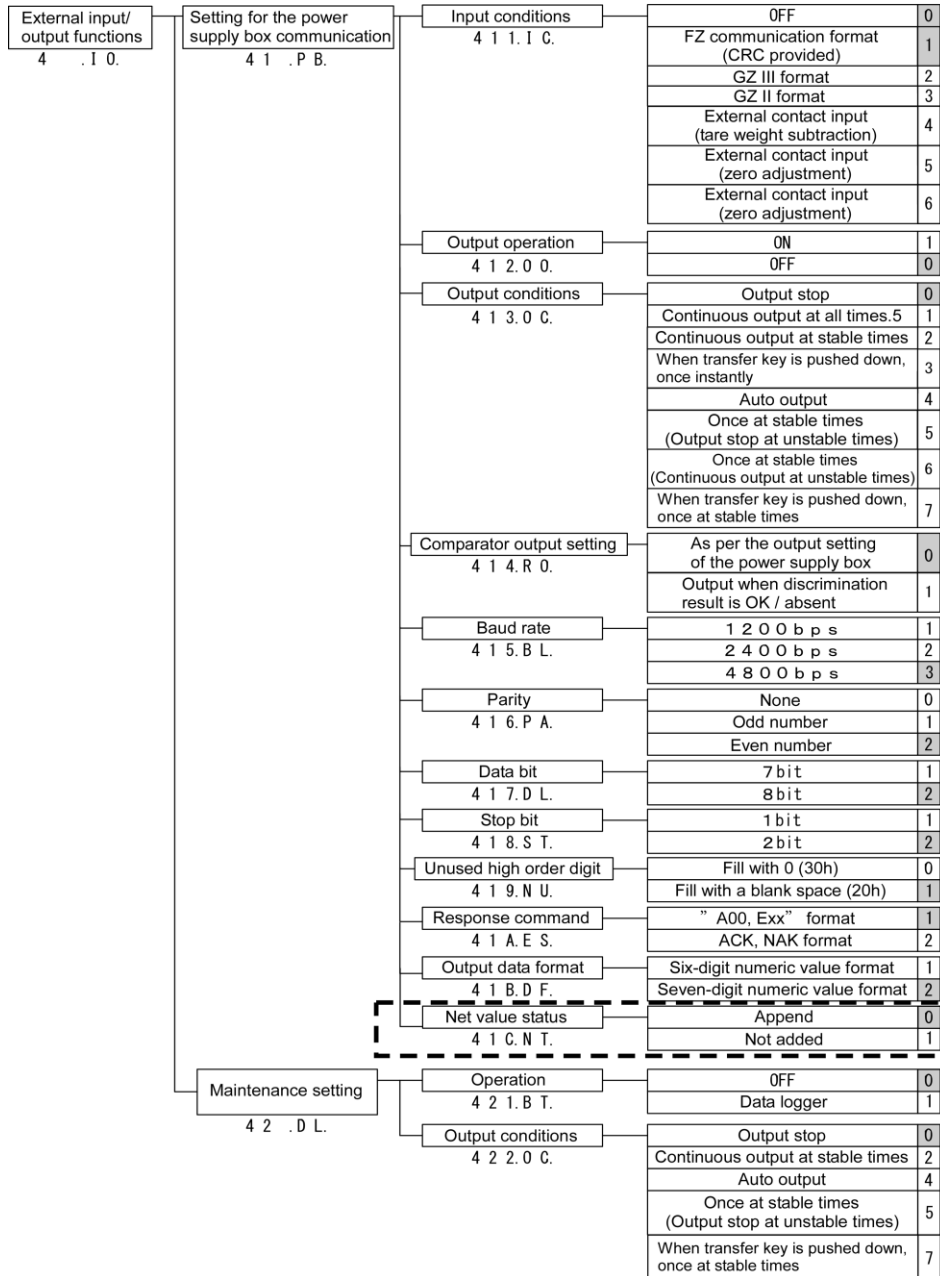

Can not be used.



**6-2 Connector terminal numbers and their functions**

Input/output to and from an external device such as a personal computer via the RS-232C is available. The RS-232C interface for this product is the D-SUB9P type.  
 The RS-232C connector pin alignment for this product is as shown below:

D-SUB9P male connector  
 Cable fixing screw : No.4-40 UNC

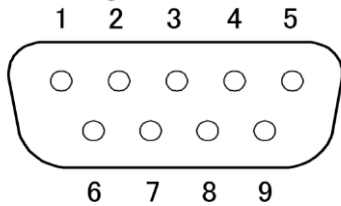

Terminal no	Signal name	Input/output	Function
1	—	—	—
2	RXD	Input	Incoming data
3	TXD	Output	Transmit data
4	—	—	—
5	GND	—	Signal grounding
6	—	—	—
7	—	—	—
8	—	—	—
9	—	—	—

**6-3 FZ communication format (CRC provided)**

Please contact our local dealer for details.

**6-4 GZIII format**

**6-4-1 Basic communication specification**

Items	Description
Line used	Specific line
Communication method	Full-duplex communication method
Synchronization method	Asynchronous communication method
Circuit construction	Point-to-point
Electrical specification	RS-232C
Baud rate	1200bps / 2400bps / 4800bps/9600bps/19200bps/38400bps
Transmission code	Start bit: 1 bit
Composition	Parity bit: None / Odd number / Even number
	Data bit: 7 bits / 8 bits
	Stop bit: 1 bit / 2 bits

**6-4-2 Basic data output format**

Composed of 26 characters including a terminator (CR=0DH / LF=0AH)  
 (Parity bit: None, Stop bit: 2 bits)

1	2	3	4	5	6	7	8	9	10	11	12	13	(SP): space (RE): reserve
S1	C1	(SP)	T1	T2	T3	T4	T5	T6	D1	D2	D3	D4	
14	15	16	17	18	19	20	21	22	23	24	25	26	
D5	D6	D7	D8	D9	D10	D11	D12	U1	U2	(RE)	CR	LF	

ERROR

1	2	3	4	5	6	7	8	9	10	11	12	13	(SP): space
*	*	(SP)	E	R	R	O	R	(SP)	*	*	*	*	
14	15	16	17	18	19	20	21	22	23	24	25	26	
*	*	*	*	*	*	*	*	*	*	(SP)	CR	LF	

**6-4-3 Meaning of the data**

Symbol	Code	Description
[S1] (1 character) Represents the status.		
(SP)	0x20	Data stable
*	0x2A	Data unstable
[C1] (1 character) Represents the result of comparator function.		
(SP)	0x20	Comparator result : Proper(OK) or No result Over(HI) Shortage(LO) Rank(1-5)
H	0x48	
L	0x4C	
1-5	0x31 - 0x35	
[T1-T6] (6 characters) Represents the type of the data.		
(SP) (SP) (SP) (SP) (SP) (SP)	0x20 0x20 0x20 0x20 0x20 0x20	Net amount (not tared)
N E T (SP) (SP) (SP) (SP)	0x4E 0x45 0x54 0x20 0x20 0x20	Net amount (tared)
P T (SP) (SP) (SP) (SP)	0x50 0x54 0x20 0x20 0x20 0x20	Preset tare weight
T A R E (SP) (SP)	0x54 0x41 0x52 0x45 0x20 0x20	Tare weight
T O T A L (SP)	0x54 0x4F 0x54 0x41 0x4C 0x20	Accumulated value (Total value)
G R O S S (SP)	0x47 0x52 0x4F 0x53 0x53 0x20	Total amount (Gross)
[D1-D12] (12 characters) Numeric value data is stored.		
+	0x2B	When the data are 0 or positive
-	0x2D	When the data are negative
0 - 9	0x30 - 0x39	Numeric value (0 - 9)
.	0x2E	Decimal point (floating decimal point)
[	0x5B	The number surrounded by '['and']' means auxiliary indication
]	0x5D	
(SP)		-Spaces fill the top of the data. -Output to the least significant digit in the absence of a decimal point -Unused high-order digit
[U1, U2] (2 characters) Represents the unit of numeric value data.		
(SP)	g	0x20 0x67 g (gram)
k	g	0x6B 0x67 kg (kilogram)
(SP)	#	0x20 0x23 # (coefficient scale)
(SP)	%	0x20 0x25 % (percent)

### 6-4-4 Input command composition

Composed of four characters including a terminator (CR=0DH / LF=0AH).

1	2	3	4
C1	C2	CR	LF

### 6-4-5 Transmission procedure

- 1 Send an input command from an external device to the scale.  
Since transmission and reception are performed by way of full-duplex communication method, the input command can be transmitted irrespective of the transmission timing from the scale.
- 2 When the scale has successfully executed the input command received, the scale sends a normal response or the data requested by the input command. In the case of unsuccessful completion or reception of an invalid input command (error), the scale sends an error response. In the normal operation, the scale normally sends a response within one second after an input command is transmitted.  
However, the response is sent after completion of the processing when:
  - (1) A tare weight subtraction command or a zero adjustment command is received when the setting menu is set to the "17 .TA. 1 Stability waiting", or
  - (2) It takes time to process the input command received.
 In addition, input commands received in other than the scale mode are neglected.



After transmitting an input command from an external device, please do not send a next input command till receiving a response from the scale.

### 6-4-6 Command format



Please take care not to take alphabetical "O" for Arabic number "0."

C1	C2	Code (C1)	Code (C2)	Description	Response	
					A00, Exx format	ACK, NAK format
T	(SP)	0x54	0x20	Tare weight subtraction	A00 : Normal completion E01 : Command error E04 : Tare weight subtraction unavailable	ACK : Normal response  NAK : Abnormal response
Z	(SP)	0x5a	0x20	Zero subtraction	A00 : Normal completion E01 : Command error E04 : Zero adjustment unavailable	
O	0	0x4f	0x30	Output stop	A00 : Normal completion  E01 : Command error	
O	1	0x4f	0x31	Continuous output at all times		
O	2	0x4f	0x32	Continuous output at stable times (Output stop at unstable times)		
O	3	0x4f	0x33	Push down [Transfer] key for one-time instant output.		
O	4	0x4f	0x34	Auto output		
O	5	0x4f	0x35	One-time output at stable times (Output stop at unstable times)		
O	6	0x4f	0x36	One-time output at stable times (Continuous output at unstable times)		
O	7	0x4f	0x37	Push down [Transfer] key for one-time output at stable times.		
O	8	0x4f	0x38	One-time instant output		
O	9	0x4f	0x39	One-time output after stability is obtained		

**6-5 GZII format**

This is different from “6-4 GZIII format” only in the operation of the T-command. In the GZII format, the tare weight subtraction / zero adjustment is executed by the T-command. For other specifications, please refer to “6-4 GZIII format”.

**6-5-1 Command format**

 **CAUTION** Please take care not to take alphabetical “O” for Arabic number “0.”

C1	C2	Code (C1)	Code (C2)	Description	Response	
					A00, Exx format	A00, Exx format
T	(SP)	0x54	0x20	Tare weight subtraction / Zero adjustment	A00 : Normal completion E01 : Command error E04 : Tare weight subtraction / Zero adjustment unavailable	ACK : Normal response
O	0	0x4f	0x30	Output stop	A00 : Normal completion  E01 : Command error	NAK : Abnormal response
O	1	0x4f	0x31	Continuous output at all times		
O	2	0x4f	0x32	Continuous output at stable times (Output stop at unstable times)		
O	3	0x4f	0x33	Push down [Transfer] key for one-time instant output.		
O	4	0x4f	0x34	Auto output		
O	5	0x4f	0x35	One-time output at stable times (Output stop at unstable times)		
O	6	0x4f	0x36	One-time output at stable times (Continuous output at unstable times)		
O	7	0x4f	0x37	Push down [Transfer] key for one-time output at stable times.		
O	8	0x4f	0x38	One-time instant output		
O	9	0x4f	0x39	One-time output after stability is obtained		

**6-6 Response**

**6-6-1 Response command format (when set to the A00, Exx format)**

Composed of five characters including a terminator (CR=0DH / LF=0AH)

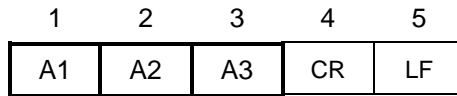

**6-6-2 Response command**

A1	A2	A3	Code (A1)	Code (A2)	Code (A3)	Description
A	0	0	41H	30H	30H	Normal completion
E	0	1	45H	30H	31H	※Command error (Abnormal command received)
E	0 - 9	0 - 9	45H	30H - 39H	30H - 39H	(Other than E01) Interruption of processing, erroneous completion of processing, other errors

**6-6-3 Response command format (when set to the ACK, NAK format)**

Composed of one character with no terminator



**6-6-4 Response command**

A1	Code (A1)	Description
ACK	06H	Positive response
NAK	15H	Negative response

**6-7 External contact input (tare weight subtraction / zero adjustment / tare weight subtraction & zero adjustment)**

Making the RXD signal (terminal no. 2) of the power supply box communication Lo active for longer than 400 ms makes the contact input valid.

Reference	Data can be output even during the selection of external contact input.
-----------	---

<b>CAUTION</b>	(1) While external contact input is selected, command input is not available. (2) There is no response command corresponding to external contact input.
----------------	--

**6-8 Power supply box communication setting**

Perform the power supply box communication setting in line with the peripheral device to which the output is transmitted.

**1** Select a setting menu.  
 Select the power supply box communication setting.  
 ("2-7-2 Operation of the setting menu, setting of various functions" and "6-1 Hierarchy of the external input/output functions")

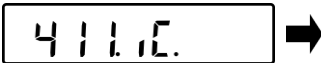
**2** Set the input conditions.  
  
 Inputting of the setting value

- Push the [Direction] key.  
 Select "411.IC.". Input a setting value.
- 「411.IC. 0」 : OFF
  - 「411.IC. 1」 : FZ communication format (CRC provided)
  - 「411.IC. 2」 : GZIII format
  - 「411.IC. 3」 : GZII format
  - 「411.IC. 4」 : External contact input (Tare weight subtraction)
  - 「411.IC. 5」 : External contact input (Zero adjustment)
  - 「411.IC. 6」 : External contact input (Tare weight subtraction /Zero adjustment)

**3** Set the output operation.  
  
 Inputting of the setting value

- Push the [Direction] key.  
 Select "412.OO.". Input a setting value.
- 「412.OO. 0」 : OFF
  - 「412.OO. 1」 : ON

4

Set the output conditions.

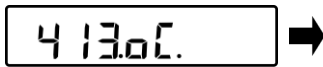

Inputting of the setting value

Push the [Direction] key.

Select "413.OC.".

Input a setting value.

- 「413.OC. 0」 : Output stop
- 「413.OC. 1」 : Continuous output at all times
- 「413.OC. 2」 : Continuous output at stable times
- 「413.OC. 3」 : After transfer key is pushed down, once instantly
- 「413.OC. 4」 : Auto output
- 「413.OC. 5」 : Once at stable times (Output stop at unstable times)
- 「413.OC. 6」 : Once at stable times (Continuous output at stable times)
- 「413.OC. 7」 : After transfer keypad is pushed down, once at stable times

5

Set the comparator output.



Inputting of the setting value

Push the [Direction] key.

Select "414.RO.".

Input a setting value.

- 「414.RO. 1」 : As per the output setting of the power supply box
- 「414.RO. 2」 : Output when discrimination result is OK or absent

6

Set the communication condition.

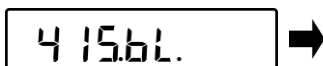

Inputting of the setting value

Push the [Direction] key.

Select "415.BL.".

Input a setting value.

- 「415.BL. 1」 : 1200 bps
- 「415.BL. 2」 : 2400 bps
- 「415.BL. 3」 : 4800 bps

7

Set the parity bit.

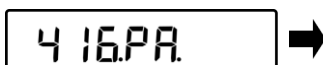

Inputting of the setting value

Push the [Direction] key.

Select "416.PA.".

Input a setting value.

- 「416.PA. 0」 : None
- 「416.PA. 1」 : Odd number
- 「416.PA. 2」 : Even number

8

Set the data bit.

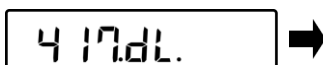

Inputting of the setting value

Push the [Direction] key.

Select "417.DL.".

Input a setting value.

- 「417.DL. 1」 : 7 bits
- 「417.DL. 2」 : 8 bits



9

Set the stop bit.



Inputting of the setting value

Push the [Direction] key.

Select "418.ST."

Input a setting value.

「418.ST. 1」 : 1 bit

「418.ST. 2」 : 2 bits

10

Set unused high order digit.



Inputting of the setting value

Push the [Direction] key.

Select "419.NU."

Input a setting value.

「419.NU. 0」 : Fill with 0(30h).

「419.NU. 1」 : Fill with a blank space (20h).

11

Set the response command format.

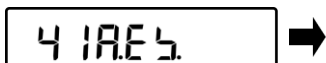

Inputting of the setting value

Push the [Direction] key.

Select "41A.ES."

Input a setting value.

「41A.ES. 1」 : "A00, Exx" format

「41A.ES. 2」 : "ACK, NAK" format

12

Set the output data format.

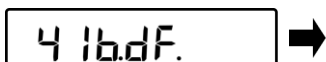

Inputting of the setting value

Push the [Direction] key.

Select "41B.DF."

Input a setting value.

「41B.DF. 1」 : 6-digit numeric value format

「41B.DF. 2」 : 7-digit numeric value format

13

Set the net value status output.

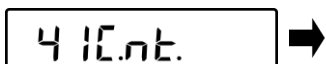

Inputting of the setting value

Push the [Direction] key.

Select "41C.NT."

Input a setting value.

「41C.NT. 0」 : None

「41C.NT. 1」 : Append

	Output conditions "413.oc.1", "413.oc.3" "413.oc.6" can not be used.
--	--

**6-9 Maintenance setting**

Setting menu "42.DL." are for the purpose of service maintenance. Please refrain from performing setting.

	If you should have performed setting, please notify the store where you purchased the product.
--	--

# 7 Functions related to the lock

Perform the setting for the prohibition of change of menu items and the disabling of key operation, etc.

## 7-1 Hierarchy of functions related to the lock

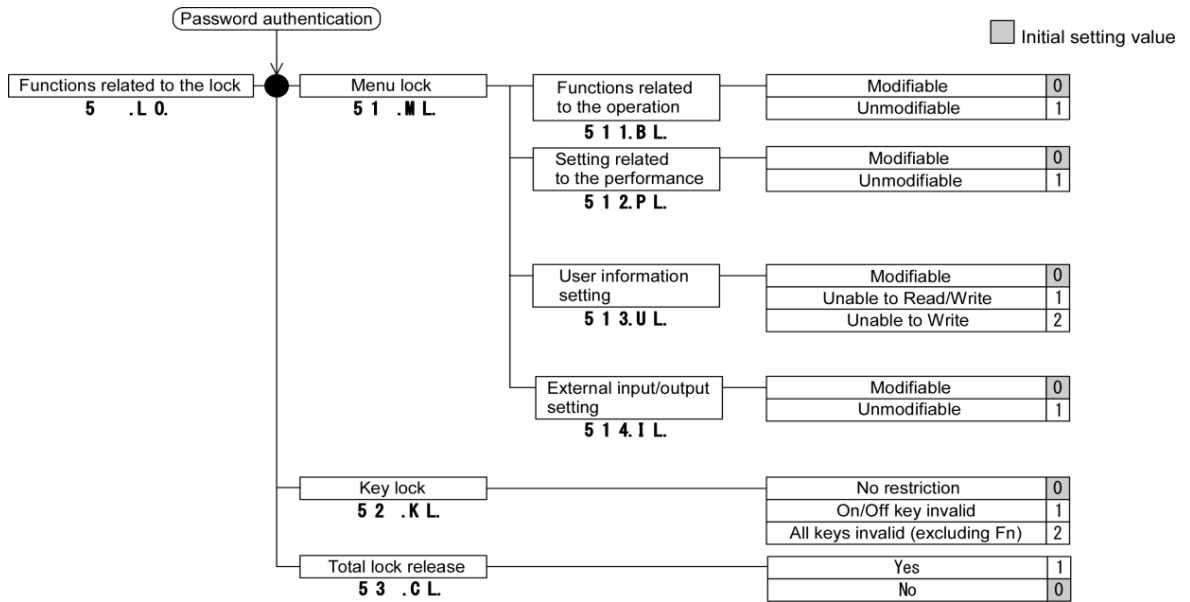

## 7-2 Locking of functions related to the operation

Various setting menus can be locked.

- 1 Select a setting menu.  
Select the menu lock setting.  
(“2-7-2 Operation of the setting menu, setting of various functions” and “7-1 Hierarchy of functions related to the lock”)

- 2 Set the functions related to the operation lock.

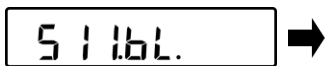

Inputting of the setting value

Push the [Direction] key.  
Select “511.BL.”.  
Input a setting value.  
「511.BL. 0」 : Modifiable  
「511.BL. 1」 : Unmodifiable

- 3 Set the functions related to the performance lock.

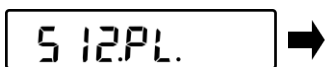

Inputting of the setting value

Push the [Direction] key.  
Select “512.PL.”.  
Input a setting value.  
「512.PL. 0」 : Modifiable  
「512.PL. 1」 : Unmodifiable

**4** Set the user information setting lock.

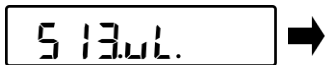

Inputting of the setting value

Push the [Direction] key.  
 Select "513.UL."  
 Input a setting value.  
 「513.UL. 0」 : Modifiable  
 「513.UL. 1」 : Unable to Read/Write  
 「513.UL. 2」 : Unable to Write

**5** Set the external input/output setting lock.

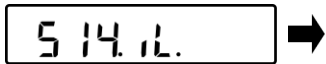

Inputting of the setting value

Push the [Direction] key.  
 Select "514.IL."  
 Input a setting value.  
 「514.IL. 0」 : Modifiable  
 「514.IL. 1」 : Unmodifiable

**7-3 Key lock function**

Key operation can be locked.

- 1** Select a setting menu.  
 Select the key lock setting.  
 ("2-7-2 Operation of the setting menu, setting of various functions" and "7-1 Hierarchy of functions related to the lock")

**2** Set the functions related to the operation lock.

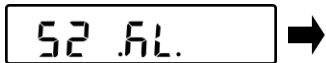

Inputting of the setting value

Push the [Direction] key.  
 Select "52.KL."  
 Input a setting value.  
 「52.KL. 0」 : No restriction  
 「52.KL. 1」 : On/Off key invalid  
 「52.KL. 2」 : All keys invalid

**7-4 Total lock release**

All locks that have been set can be released.

- 1** Select a setting menu.  
 Select the total lock release setting.  
 ("2-7-2 Operation of the setting menu, setting of various functions" and "7-1 Hierarchy of functions related to the lock")

**2** Set the total lock release.



Inputting of the setting value

Push the [Direction] key.  
 Select "53.CL."  
 Input a setting value.  
 「53.CL. 0」 : No total release  
 「53.CL. 1」 : Total release

# 8 Controlling and adjustment functions

Perform setting of the scale ID, the span adjustment and the date and time.

## 8-1 Hierarchy of controlling and adjustment functions

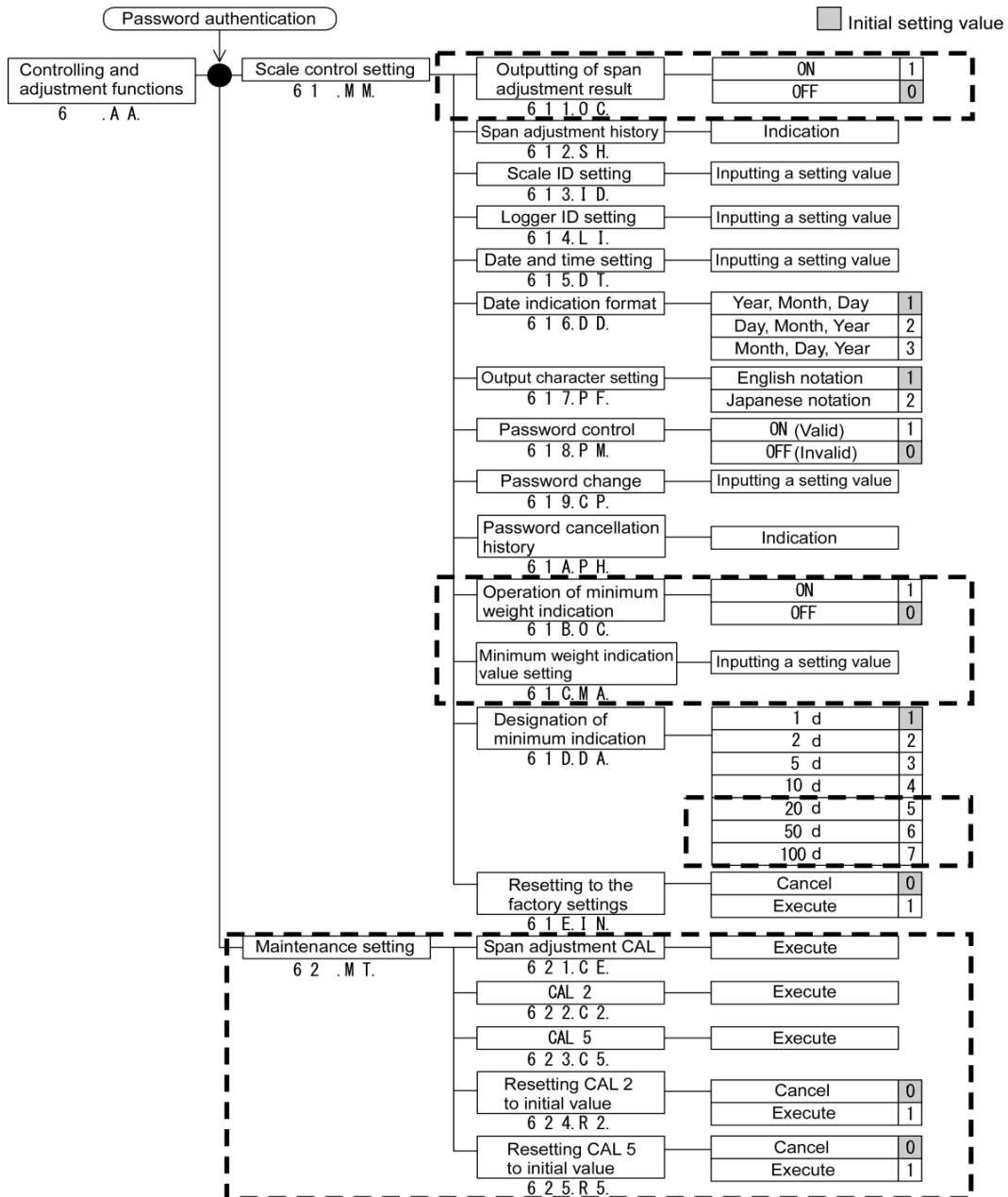

Legal Metrology

” [ ] “ can not be used.

**8-2 Outputting of the span adjustment result**

Legal Metrology	Can not be used.
--------------------	------------------

The span adjustment result can be output to a dedicated printer.

- 1 Select a setting menu.  
 Select the outputting of the span adjustment result.  
 (“2-7-2 Operation of the setting menu, setting of various functions” and “8-1 Hierarchy of controlling and adjustment functions”)

- 2 Set the outputting of the span adjustment result.

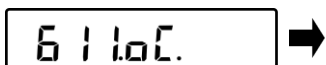

Inputting of the setting value

Push the [Direction] key.  
 Select “611.OC.”.  
 Input a setting value.  
 「611 .OC. 0」 : To be output  
 「611 .OC. 1」 : Not to be output

**8-3 Span adjustment history**

This is a function to check the span adjustment history. Ten history records can be stored in all.

- 1 Select a setting menu.  
 Select the indication of the span adjustment history.  
 (“2-7-2 Operation of the setting menu, setting of various functions” and “8-1 Hierarchy of controlling and adjustment functions”)

- 2 Select the span adjustment history.

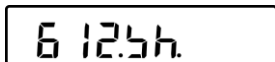

Push the [Direction] key.  
 Select “612.SH.”.

- 3 Select a history to be checked.



Push the [Enter] key.  
 The indication changes from “CAL. HIST.” to “HIS. 1”.

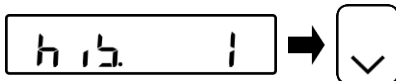

Push the [Direction] key.  
 With each pushing of the [Direction] key, the indication changes to “HIS. 2”, “HIS. 3” ----- till “HIS. 10”.

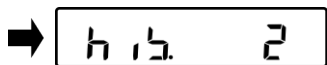

**4** Confirm the history.

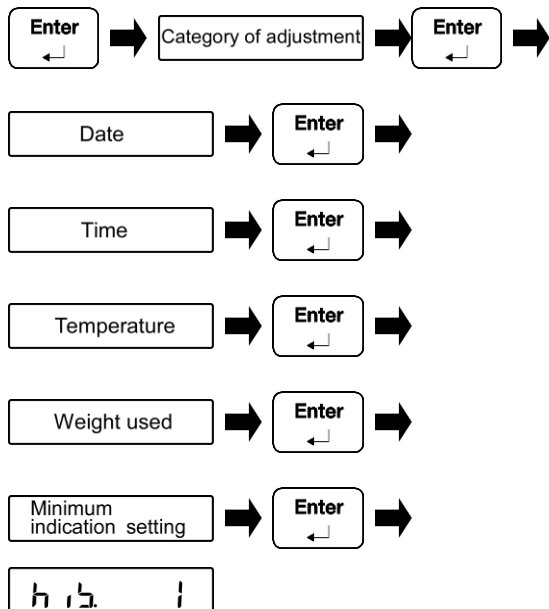

Push the [Enter] key.

The indication changes to the “Category of adjustment”.

With each pushing of the [Enter] key, the indication changes to “Date”, “Time”, “Temperature”, “Weight used” and “Minimum indication setting” sequentially.

The indication returns to the history selection in the end.

**5** The operation mode returns to the scale mode.

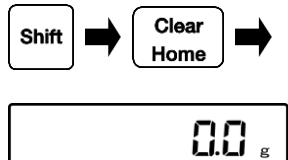

Return to the scale mode with the [Shift] and the [Clear Home] keys.

**8-4 Scale ID setting**

An ID can be set to discriminate a vessel.

- 1** Select a setting menu.  
Select the scale ID setting.  
 (“2-7-2 Operation of the setting menu, setting of various functions” and “8-1 Hierarchy of controlling and adjustment functions”)

- 2** Set the scale ID.



Push the [Direction] key to select “613.ID.”.  
Input an ID.

“2-7-4 Operation of the setting menu, inputting of characters”

**8-5 Maintenance setting**

Setting menu “614.LI.” are for the purpose of service maintenance. Please refrain from performing setting.

	If you should have performed setting, please notify the store where you purchased the product.
--	--

### 8-6 Date and time setting

**1** Select a setting menu.  
 Select the date and time setting.  
 (“2-7-2 Operation of the setting menu, setting of various functions” and “8-1 Hierarchy of controlling and adjustment functions”)

**2** Set the date and time.



Push the [Direction] key.

Select “615.BT.”

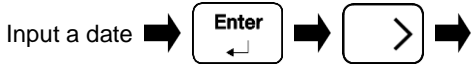

Input date and time.

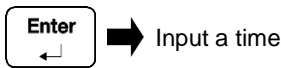

“2-7-4 Operation of the setting menu, inputting of characters”

### 8-7 Date indication format

Date indication format can be selected.

**1** Select a setting menu.  
 Select the date indication format.  
 (“2-7-2 Operation of the setting menu, setting of various functions” and “8-1 Hierarchy of controlling and adjustment functions”)

**2** Set the date indication format.



Inputting of the setting value

Push the [Direction] key.

Select “616.DD.”.

Input a setting value.

「616 .DD. 1」 : Year, Month, Day

「616 .DD. 2」 : Day, Month, Year

「616 .DD. 3」 : Month, Day, Year

### 8-8 Output character setting

Characters output to a dedicated printer can be selected.

**1** Select a setting menu.  
 Select the output character setting.  
 (“2-7-2 Operation of the setting menu, setting of various functions” and “8-1 Hierarchy of controlling and adjustment functions”)

**2** Set the output character.

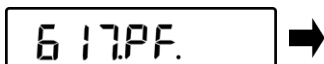

Inputting of the setting value

Push the [Direction] key.

Select “617.PF.”.

Input a setting value.

「617 .PF. 1」 : English

「617 .PF. 2」 : Japanese

### 8-9 Password control

This function is used for controlling by a password.

- 1 Select a setting menu.  
Select the password control setting.  
(“2-7-2 Operation of the setting menu, setting of various functions” and “8-1 Hierarchy of controlling and adjustment functions”)

- 2 Set the password control.

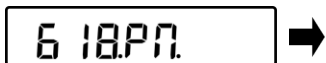

Inputting of the setting value

Push the [Direction] key.◦

Select “618.PM.”

Input a setting value.

「618 .PM. 1」 : Valid

「618 .PM. 0」 : Invalid

### 8-10 Password change



Take care not to forget the password. If you should forget it, please notify the store where you purchased the product, or our sales department or service center.

Reference

A password is not set at the time of shipment.

- 1 Select a setting menu.  
Select the password change.  
(“2-7-2 Operation of the setting menu, setting of various functions” and “8-1 Hierarchy of controlling and adjustment functions”)

- 2 Set the password change.



Push the [Direction] key.◦

Select “619.CP.”

Input a password.

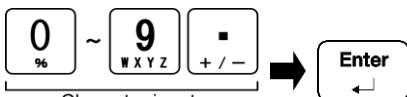

Character input  
(max. 7 digits)

Push the [Enter] key.◦

“2-7-4 Operation of the setting menu, inputting of characters”

- 3 The operation mode returns to the scale mode.

Push the [Direction] key.◦

Select “619.CP.”

Return to the scale mode with the [Shift] and the [Clear Home] keys.





### 8-11 Password cancellation history

This function is used for checking the password cancellation history. 100 history records are stored in all.

- 1 Select a setting menu.  
Select the password cancellation history.  
(“2-7-2 Operation of the setting menu, setting of various functions” and “8-1 Hierarchy of controlling and adjustment functions”)

- 2 Select the password cancellation history.



Push the [Direction] key.  
Select “61A.PH.”

- 3 Select a history to be checked.

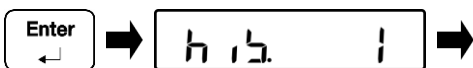

Push the [Enter] key.  
The indication changes to “HIS. 1”.

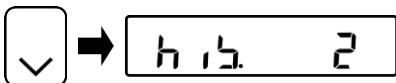

Push the [Direction] key.  
With each pushing of the [Direction] key, the indication changes to “HIS. 2”, “HIS. 3” ----- till “HIS. 100”.

- 4 Confirm the history.

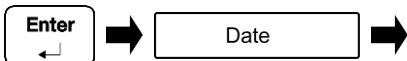

Push the [Enter] key.  
The indication changes to “Date”.

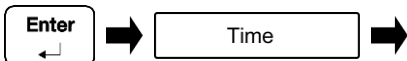

With each pushing of the [Enter] key, the indication changes to “Time”, “PASS 0” and “Date” sequentially.

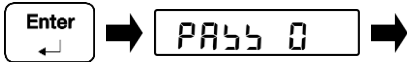

The indication returns to the history selection in the end.

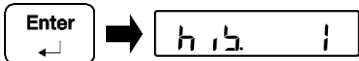

- 5 The operation mode returns to the scale mode.



Return to the scale mode with the [Shift] and the [Clear Home] keys.

## 8-12 Operation of minimum weight indication

Legal  
Metrology

Can not be used.

This is to be set when using the minimum weighed value indication function.

- 1 Select a setting menu.  
Select the operation of minimum weighed value indication.  
(“2-7-2 Operation of the setting menu, setting of various functions” and “8-1 Hierarchy of controlling and adjustment functions”)

- 2 Select the operation of minimum weighed value indication.

6 1b.0C. →

Inputting of the setting value

Push the [Direction] key.  
Select “61B.OC.”.

Input a setting value.

「61B .OC. 1」 : Operable

「61B .OC. 0」 : Inoperable

## 8-13 Minimum weight indication value setting

Legal  
Metrology

Can not be used.

Reference

This is a function valid only when “61B. OC. 1” is set in “8-12 Operation of minimum weight indication”.

- 1 Select a setting menu.  
Select the minimum weight indication value setting.  
(“2-7-2 Operation of the setting menu, setting of various functions” and “8-1 Hierarchy of controlling and adjustment functions”)

- 2 Select the minimum weight indication value setting.

6 1C.MA. →

Inputting of a minimum weighed value.

(“2-7-3 Operation of the setting menu, inputting of numeric values”)

Push the [Direction] key.

Select “61C.MA.”

Input a minimum weighed value.

Reference

- (1) Indication of a value smaller than the preset minimum weighed value flashes.
- (2) A value indicated smaller than the preset minimum weighed value is not output to an external device.

**8-14 Designation of minimum indication**

**1** Select a setting menu.  
 Select the designation of minimum indication.  
 (“2-7-2 Operation of the setting menu, setting of various functions” and “8-1 Hierarchy of controlling and adjustment functions”)

**2** Designate a minimum indication.

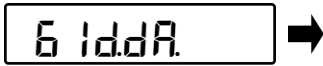

Inputting of the setting value

Push the [Direction] key.  
 Select “61D.DA.”

Input a setting value.

- 「61D .DA. 1」 : 1 count
- 「61D .DA. 2」 : 2 counts
- 「61D .DA. 3」 : 5 counts
- 「61D .DA. 4」 : 10 counts
- 「61D .DA. 5」 : 20 counts
- 「61D .DA. 6」 : 50 counts
- 「61D .DA. 7」 : 100 counts

<div style="border: 1px solid black; padding: 2px; display: inline-block;">                 Legal                  Metrology             </div>	“61D.DA.5-7” can not be used.
---	-------------------------------

**【Minimum indication list by model】**

Setting value	620	3200	6200	15K	30K
61D .DA. 1	0.001 g	0.01 g	0.01 g	0.1 g	0.1 g
SEL .DA. 1					
61D .DA. 2	0.002 g	0.02 g	0.02 g	0.2 g	0.2 g
SEL .DA. 2					
61D .DA. 3	0.005 g	0.05 g	0.05 g	0.5 g	0.5 g
SEL .DA. 3					
61D .DA. 4	0.01 g	0.1 g	0.1 g	1 g	1 g
SEL .DA. 4					
61D .DA. 5	0.02 g	0.2 g	0.2 g	2 g	2 g
SEL .DA. 5					
61D .DA. 6	0.05 g	0.5 g	0.5 g	5 g	5 g
SEL .DA. 6					
61D .DA. 7	0.1 g	1 g	1 g	10 g	10 g
SEL .DA. 7					

Reference

Setting value	60K	100K	200K	150KF	300KF
61D .DA. 1	0.1 g	1 g	1 g	1 g	1 g
SEL .DA. 1					
61D .DA. 2	0.2 g	2 g	2 g	2 g	2 g
SEL .DA. 2					
61D .DA. 3	0.5 g	5 g	5 g	5 g	5 g
SEL .DA. 3					
61D .DA. 4	1 g	10 g	10 g	10 g	10 g
SEL .DA. 4					
61D .DA. 5	2 g	20 g	20 g	20 g	20 g
SEL .DA. 5					
61D .DA. 6	5 g	50 g	50 g	50 g	50 g
SEL .DA. 6					
61D .DA. 7	10 g	100 g	100 g	100 g	100 g
SEL .DA. 7					

**8-15 Reset to the factory settings**

**1** Select a setting menu.  
 Select the factory settings.  
 (“2-7-2 Operation of the setting menu, setting of various functions” and “8-1 Hierarchy of controlling and adjustment functions”)

**2** Reset to the factory settings.

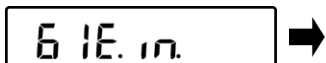

Inputting of the setting value

Push the [Direction] key.  
 Select “61E.IN.”  
 Input a setting value.  
 「61E .IN. 0」 : Not to be reset  
 「61E .IN. 1」 : To be reset

**8-16 Span adjustment**

Legal  
 Metrology

Can not be used.

Span adjustment is to decrease the difference between an indicated value and the true value (mass). This must be performed without fail in the case of doing high-accuracy weighing work. Because an electronic scale is affected by the acceleration of gravity, adjustment is needed at every weighing location. The adjustment is also needed when (1) using a long period and (2) an accurate indication does not appear any longer.

**CAUTION**

- (1) An external weight used for the span adjustment shall be the one equivalent to the OIML F1 class.
- (2) The span adjustment significantly affects the weighing accuracy. Please read this procedure carefully before getting to the adjustment.

**1** Select a setting menu.  
 Select the span adjustment.  
 (“2-7-2 Operation of the setting menu, setting of various functions” and “8-1 Hierarchy of controlling and adjustment functions”)

**2** Select the span adjustment.

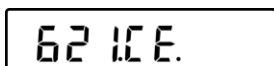

**3** Select the minimum indication

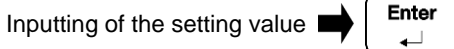
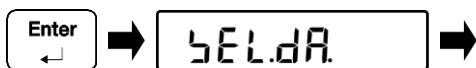

(List of the reference “8-14 Designation of minimum indication”)

Push the [Direction] key.  
 Select “621.CE.”

Push the [Enter] key.  
 The indication changes to “SEL. DA.”  
 Push the [Direction] key and select a setting value.

- 「SEL.DA. 1」 : 1 count
- 「SEL.DA. 2」 : 2 counts
- 「SEL.DA. 3」 : 5 counts
- 「SEL.DA. 4」 : 10 counts
- 「SEL.DA. 5」 : 20 counts
- 「SEL.DA. 6」 : 50 counts
- 「SEL.DA. 7」 : 100 counts

Push the [Enter] key.

**4** Select a weight used for the span adjustment.

①

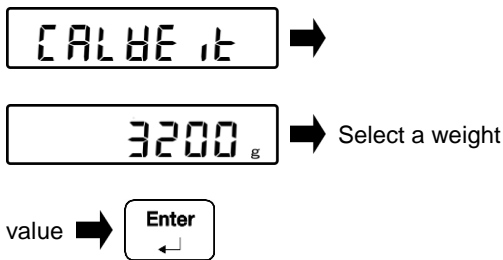

(List of the reference "8-16 Span adjustment")

After an indication of "CALWE IT" appears for one second, the indication changes to the indication of weight selection used for the span adjustment.

Push the [Direction] key and select a weight used for the span adjustment.

Push the [Enter] key.

**5** Select a weight used for the span adjustment.

②

【When USER IN is selected】

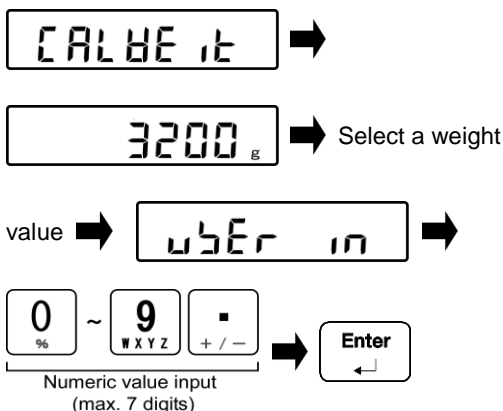

(List of the reference "8-16 Span adjustment")

After an indication of "CALWE IT" appears for one second, the indication changes to the indication of weight selection used for the span adjustment.

Push the [Direction] key and select a weight used for the span adjustment.

Select "USER IN"

Input with [Numeric keypad] the weight value used for the span adjustment.

Push the [Enter] key.

**6** Zero-point adjustment starts.

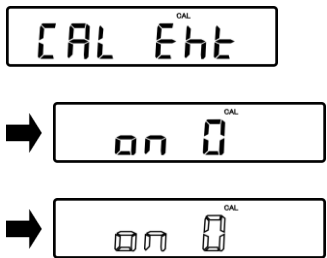

The indication changes to the flashing of "CAL EHT", "on 0", and then "on 0", followed by the starting of the zero-point adjustment.

**7** The span adjustment starts.

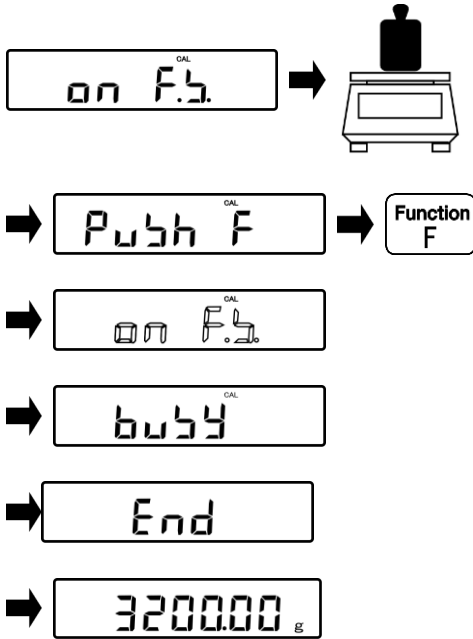

After completion of the zero-point adjustment and the indication changing to "on F.S.", place the weight in the center of the weighing pan. The indication changes to "PUSH F".

Push the [Function F] key.

The indication changes to the flashing of "on F.S.", followed by the start of the span adjustment.

On completion of the span adjustment, the indication automatically changes to "BUSY" then "END", followed by return to the state of weighing.

**8** Outputting of the span adjustment result

In the case "8-2 Outputting of the span adjustment result" was set to "611 .OC. 0": To be output", the span adjustment result is output to a peripheral device.

Reference	At the models of Max 30kg or more, "PUSH F" is indicated at step 7.
-----------	---

(1) List of weights used for the span adjustment by model

Model name	FZ623Ex	FZ3202Ex	FZ6202Ex	FZ15001Ex	FZ30K0.1GEx
Selectable weight	620 g	3200 g	6200 g	15000 g	30000 g
	600 g	3000 g	6000 g		
	500 g	2000 g	5000 g	10000 g	20000 g
	200 g	1000 g	2000 g	5000 g	10000 g
	100 g	500 g	1000 g	2000 g	5000 g
	10 g	50 g	100 g	2000 g	500 g
“USER IN” selection	0.001 g - 620.000 g	0.01 g - 3200.00 g	0.01 g - 6200.00 g	0.1 g - 15000.0 g	0.1 g - 30000.0 g

Model name	FZ60K0.1GEx	FZ100K1GEx	FZ200K1GEx	FZ150K1GFEx	FZ300K1GFEx
Selectable weight	60000 g	100000 g	200000 g	150000 g	300000 g
	50000 g			100000 g	200000 g
	20000 g	50000 g	100000 g	50000 g	100000 g
	10000 g	20000 g	20000 g	20000 g	50000 g
	1000 g	2000 g	2000 g	2000 g	5000 g
“USER IN” selection	0.1 g - 60000.0 g	1 g - 100000 g	1 g - 200000 g	1 g - 150000 g	1 g - 300000 g

Reference

- (2) “PUSH F” indicates models with a weighing capacity of not less than 60 kg.
- (3) The span adjustment by the use of a weight less than the weighing capacity may possibly indicate “UC” on the main LCD. When this is the case, the weighing accuracy is not guaranteed.



Conditions under which “UC” is indicated

- When an object that is more than two times heavier than the weight that was used for the span adjustment is weighed, and
- When the minimum indication setting (“61D. DA.”), which is finer than the minimum indication setting (“SEL. DA.”) selected for the span adjustment, is performed.

### 8-17 Setting for maintenance

Setting menu “622.C2. to 625.R5.” are for the purpose of service maintenance. Please refrain from performing setting.



If you should have performed setting, please notify the store where you purchased the product.



# 9 Execution menu

## 9-1 Operation of the execution menu

To operate the execution menu from the state of weighing, chiefly execute the following procedure.

- (1) Push the [Shift] and [Function F] keys to enter the execution menu from the state of weighing.
- (2) Push to the intended execution item using the [Direction] key.
- (3) Perform execution / numeric value and/or character input with the [Enter] key.

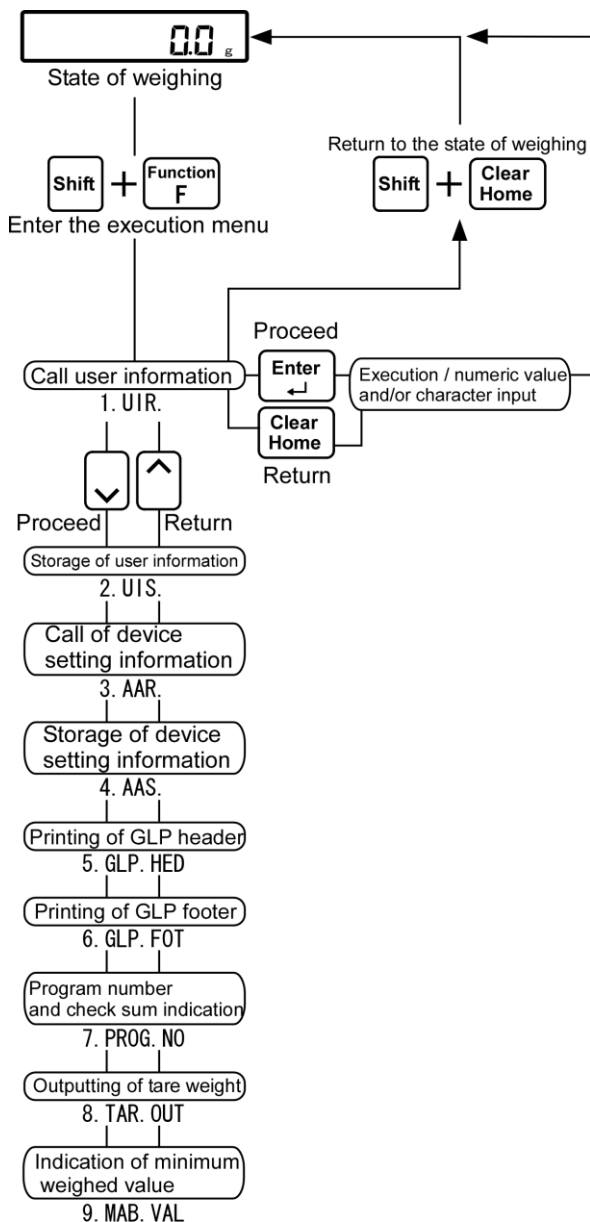

## 9-2 Calling of the registered user information

This is a function to call the setting that was registered in “9-3 Registration of user information”.

### 1 Select the execution menu mode.

Select the user information calling.

(“9-1 Operation of the execution menu”)

### 2 Select a user to be called.

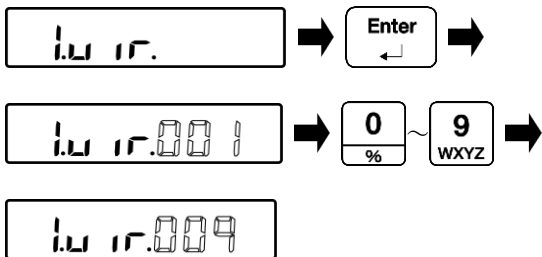

Push the [Direction] key.

Select “1.UIR.”

Push the [Enter] key.

An indication of “1. UIR. 001” appears.  
(The three-digit number flashes.)

Input a number with [Numeric keypad].

(“2-7-3 Operation of the setting menu, inputting of numeric values”)

### 3 Call the user information.

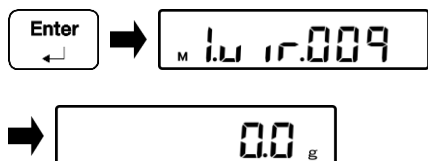

Push the [Enter] key.

The number that was input is fixed and an indication of 「 M 」 lights, followed by automatic return to the state of weighing.

Reference

- (1) If you should have input a wrong number with [Numeric keypad], push the [Clear Home] key to return it to the number entering screen.
- (2) Push the [Shift] and [Clear Home] keys to return it to the state of weighing.
- (3) The initial value of the user information has been set to “001”.

### 9-3 Registration of user information

This is a function to register the content set in “5 User information setting”.

**1** Select the execution menu mode.  
 Select the user information registration.  
 (“9-1 Operation of the execution menu”)

**2** Select user information to be registered.

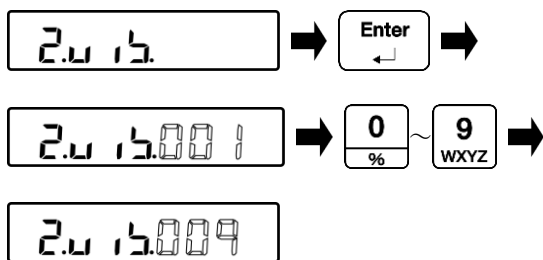

(“2-7-3 Operation of the setting menu, inputting of numeric values”)

**3** Register the user information.

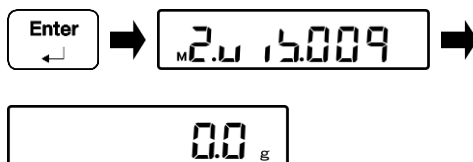

Push the [Direction] key.

Select “2.UIR.”

Push the [Enter] key.

An indication of “2. UIR. 001” appears.  
 (The three-digit number flashes.)

Input a number with [Numeric keypad].

Push the [Enter] key.

The number that was input is fixed and an indication of 「 M 」 lights, followed by automatic return to the state of weighing.

Reference

- (1) If you should have input a wrong number with [Numeric keypad], push the [Clear Home] key to return it to the number entering screen.
- (2) Push the [Shift] and [Clear Home] keys to return it to the state of weighing.

## 9-4 Calling of device setting information

This is a function to call from the backup memory the setting value of a setting menu item.

- 1 Select the execution menu mode.  
Select the calling of device setting information.  
("9-1 Operation of the execution menu")

- 2 Select the device setting information.

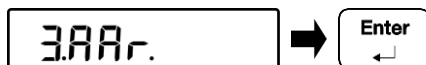

Push the [Direction] key.  
Select "3.AAR."  
Push the [Enter] key.

- 3 Password authentication  
("2-7-4 Operation of the setting menu, inputting of characters")

Input a password.

- 4 Deployment of a model-specified setting information

Push the [Enter] key.

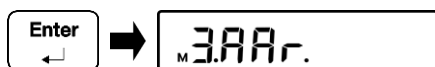

The content of the setting is deployed.  
An indication of 「 M 」 lights, followed by automatic standby.

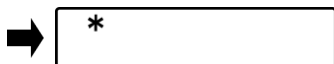
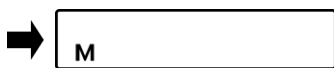

## 9-5 Storage of device setting information

This is a function to back up the present setting menu items.

- 1 Select the execution menu mode.  
Select the storage of device setting information.  
("9-1 Operation of the execution menu")

- 2 Password authentication  
("2-7-4 Operation of the setting menu, inputting of characters")

Input a password.

- 3 Store the device setting information.



Push the [Direction] key.  
Select "4.AAS."  
Push the [Enter] key.

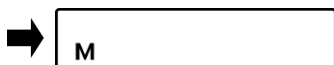

Store the content of the setting.  
An indication of 「 M 」 lights, followed by automatic return to the state of weighing.

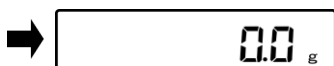

### 9-6 Printing of the GLP header

This is a function to add the GLP header at the time of printing.

Reference	Set the output operation to "412. 00. 1" in the "6-8 Power supply box communication setting".
-----------	---

- 1 Select the execution menu mode.  
 Select the GLP header printing.  
 ("9-1 Operation of the execution menu")

- 2 Print the GLP header.

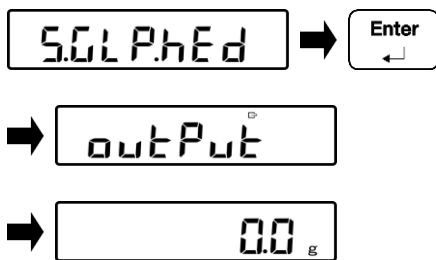

Push the [Direction] key.  
 Select "5.GLP.HED".  
 Push the [Enter] key.

An indication of "OUTPUT" appears.

Returns to the weighing mode automatically.

### 9-7 Printing of the GLP footer

This is a function to add the GLP footer at the time of printing.

Reference	Set the output operation to "412. 00. 1" in the "6-8 Power supply box communication setting".
-----------	---

- 1 Select the execution menu mode.  
 Select the GLP footer printing.  
 ("9-1 Operation of the execution menu")

- 2 Print the GLP footer.

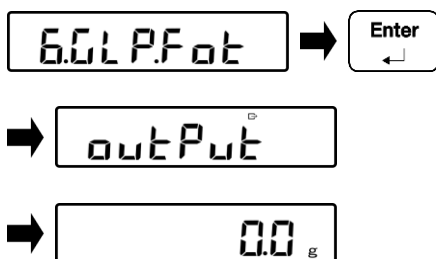

Push the [Direction] key.  
 Select "6.GLP.FOT".  
 Push the [Enter] key.

An indication of "OUTPUT" appears.

Returns to the weighing mode automatically.

**9-8 Program number and check sum indication**

**1** Select the execution menu mode.  
 Select the program number and check sum indication.  
 ("9-1 Operation of the execution menu")

**2** Indicate program number.



Push the [Direction] key.  
 Select "7.PROG.NO".  
 Push the [Enter] key.

Indicating section program number is indicated.



Push the [Enter] key again.

A weighing section program number is indicated.



**3** Indicate check sum.

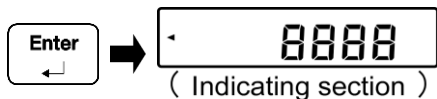

Push the [Enter] key.

Indicating section check sum is indicated.

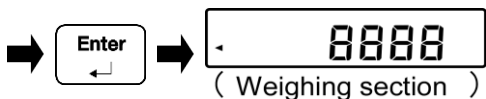

Push the [Enter] key again.

Weighing section check sum is indicated.

**4** The operation mode returns to the scale mode.

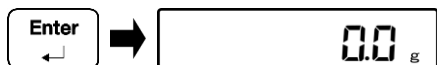

Push the [Enter] key.

Returns to the state of weighing.

## 9-9 Outputting of weight data

Reference	Output to Power supply box: Set the output operation to "412. OO. 1" in "6-8 Power supply box communication setting".
-----------	--

### 9-9-1 Outputting of tare weight

**1** Select the execution menu mode.  
Select the output of tare weight.  
(“9-1 Operation of the execution menu”)

**2** Output a tare weight.

Push the [Direction] key.  
Select "8.TAR.OUT".  
Push the [Enter] key.

An indication of "OUTPUT" appears.

Returns to the weighing mode automatically.

Reference	Tare weight can also be output by following shortcutting step at weighing mode.
-----------	---

### 9-9-2 Outputting of gross weight

**1** Output a gross weight

Push the [Shift] key.  
Push the [ ^ ] key.

### 9-9-3 Outputting of accumulated value.

#### 1 Output an accumulated value

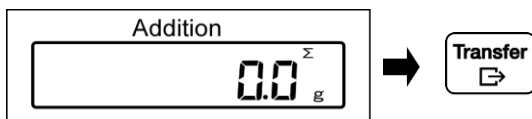

Push the [Transfer] key when accumulated value is indicated in the main LCD.

### 9-10 Indication of minimum weighed value



Can not be used.

The minimum weighed value set in the “8-13 Minimum weight indication value setting” can be checked.

#### 1 Select the execution menu mode. Select the indication of minimum weighed value. (“9-1 Operation of the execution menu”)

#### 2 Indicate the minimum weighed value.

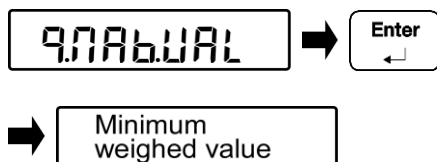

Push the [Direction] key.  
Select “9.MAB.VAL”.  
Push the [Enter] key.  
The minimum weighed value that has been set is indicated.

#### 3 The operation mode returns to the scale mode.

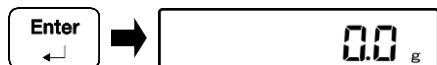

Push the [Enter] key.  
Returns to the state of weighing.



# 10 Troubleshooting

## 10-1 Error messages

Message	Cause	Countermeasures
o-Err	<ul style="list-style-type: none"> <li>The weight of an object to be weighed is in excess of the weight of the weighing capacity.</li> <li>The addition result or calculation result has exceeded the number of indication digit.</li> </ul>	<ul style="list-style-type: none"> <li>Remove the object to be weighed, divide it into two or more, and then weigh them again.</li> <li>Replace the tare with a lighter one.</li> <li>If the error still persists even after removing the object from the weighing pan, damaging of the mechanism section is suspected. Please notify the store where you purchased the product.</li> <li>Clear the calculation result, and then execute the addition computation.</li> </ul>
u-Err	<ul style="list-style-type: none"> <li>Negative load has exceeded the lower limit.</li> </ul>	<ul style="list-style-type: none"> <li>Improper setting of the weighing pan or pan base is suspected.</li> <li>Check for contact with other object.</li> <li>If the error still persists even after re-setting the weighing pan or pan base, damaging of the mechanism section is suspected. Please notify the store where you purchased the product.</li> </ul>
b-Err d-Err	<ul style="list-style-type: none"> <li>Has been affected by static electricity or noises.</li> </ul>	<ul style="list-style-type: none"> <li>Turn off the power supply box once, and then turn on it again. If the same error still persists, damaging of the electric section is suspected. Please notify the store where you purchased the product.</li> </ul>

Message	Cause	Countermeasures
L-Err	<ul style="list-style-type: none"> <li>Sample weight is too light in comparison with the memorized reference mass of the percent scale.</li> </ul>	
t-Err	<ul style="list-style-type: none"> <li>Addition computation was executed doubly due to erroneous adding operation.</li> <li>Zero or minus addition computation was executed on the plus side addition computation.</li> <li>Zero or plus addition computation was executed on the minus side addition computation.</li> </ul>	<ul style="list-style-type: none"> <li>Return the indication to zero, confirm that an asterisk 「*」 mark lights and then execute the operation of addition computation.</li> <li>When the indication is "0" or in the negative state, addition computation cannot be executed. Place an object to be weighed before executing addition computation.</li> <li>When the indication is "0" or in the positive state, addition computation cannot be executed. Remove the object to be weighed to make it negative state before executing addition computation.</li> </ul>
Locked	<ul style="list-style-type: none"> <li>In the state of being locked</li> </ul>	<ul style="list-style-type: none"> <li>Release the lock of a function concerned from the setting menu. (Refer to "7 Functions related to the lock".)</li> </ul>

Message	Cause	Countermeasures
Err001 - Err099	<ul style="list-style-type: none"> <li>A system error</li> </ul>	<ul style="list-style-type: none"> <li>Take a note of the error number and notify the store where you purchased the product.</li> </ul>

Message	Cause	Countermeasures
Err100 Err101 Err102 Err103 Err104	<ul style="list-style-type: none"> <li>Communication error in the weighing section</li> </ul>	<ul style="list-style-type: none"> <li>Check the scale cable connection.</li> </ul>
Err112 Err113 Err114	<ul style="list-style-type: none"> <li>Communication error in the power supply box</li> </ul>	<ul style="list-style-type: none"> <li>Check the communication cable connection.</li> </ul>
Err120 Err121 Err122 Err123 Err124	<ul style="list-style-type: none"> <li>Communication error</li> </ul>	<ul style="list-style-type: none"> <li>Notify the store where you purchased the product.</li> </ul>
Err200	<ul style="list-style-type: none"> <li>Internal processing error</li> </ul>	<ul style="list-style-type: none"> <li>Notify the store where you purchased the product.</li> </ul>

Message	Cause	Countermeasures
Err702	<ul style="list-style-type: none"> <li>User password input is in the wrong.</li> </ul>	<ul style="list-style-type: none"> <li>Check the password and input a correct password.</li> </ul>
Err703	<ul style="list-style-type: none"> <li>The operation key was pushed at the time of starting from the standby status.</li> </ul>	<ul style="list-style-type: none"> <li>Do not push the operation key while the scale is in the process of starting from the standby status.</li> </ul>
Err704	<ul style="list-style-type: none"> <li>Numeric keypad was pushed at the time of starting from the standby status.</li> </ul>	<ul style="list-style-type: none"> <li>Do not push the numeric keypad while the scale is in the process of starting from the standby status.</li> </ul>
Err705	<ul style="list-style-type: none"> <li>The initial zero adjustment was not completed at the time of starting from the standby status.</li> </ul>	<ul style="list-style-type: none"> <li>Check for any wind or vibration.</li> </ul>
Err706	<ul style="list-style-type: none"> <li>Out-of-range initial zero adjustment error</li> </ul>	<ul style="list-style-type: none"> <li>Check for an object to be weighed left on the weighing section.</li> </ul>
Err707	<ul style="list-style-type: none"> <li>The upper and lower limit value setting is in the wrong.</li> </ul>	<ul style="list-style-type: none"> <li>Make sure that the upper and lower limit values are within the weighing range.</li> <li>Check if the upper and lower limit values are not set the other way around.</li> </ul>
Err708	<ul style="list-style-type: none"> <li>Although the discrimination method is not relative value setting, the upper and lower limit value setting was performed in percent.</li> </ul>	<ul style="list-style-type: none"> <li>Change the discrimination method to the relative value setting.</li> </ul>
Err709	<ul style="list-style-type: none"> <li>Zero adjustment time-out error</li> </ul>	<ul style="list-style-type: none"> <li>Check for any wind or vibration.</li> </ul>
Err710	<ul style="list-style-type: none"> <li>Tare weight subtraction time-out error</li> </ul>	
Err711	<ul style="list-style-type: none"> <li>Span adjustment time-out error</li> </ul>	
Err712	<ul style="list-style-type: none"> <li>User information calling CRC error</li> </ul>	<ul style="list-style-type: none"> <li>Push the [Enter] key and turn on the power again.</li> </ul>
Err716	<ul style="list-style-type: none"> <li>The span adjustment and span test by the use of the internal weight is not reproducible</li> </ul>	<ul style="list-style-type: none"> <li>Check for any wind or vibration.</li> </ul>

## 10-2 Troubleshooting

Symptom	Cause	Countermeasures
Nothing indicated in spite of turning on power	<ul style="list-style-type: none"> <li>DC power supply cable not connected</li> </ul>	<ul style="list-style-type: none"> <li>Check DC power supply cable connection.</li> </ul>
Indication flashes Erroneous weight indication	<ul style="list-style-type: none"> <li>Power supply box is not switched on .</li> </ul>	<ul style="list-style-type: none"> <li>Make sure that power is supplied for power supply box.</li> <li>If the same error still persists in spite of correct connection and switching on the power, failure of electric section of this product or power supply box is suspected. Notify the store where you purchased the product.</li> </ul>
Error persists even after calibration	<ul style="list-style-type: none"> <li>Scale may possibly be affected by wind or vibration.</li> </ul>	<ul style="list-style-type: none"> <li>Change setting values of relevant functions referring to "4 Functions related to the performance".</li> </ul>
"M" keeps flashing	<ul style="list-style-type: none"> <li>Indication value changed due to elapse of a long period of time.</li> </ul>	<ul style="list-style-type: none"> <li>Make span adjustment referring to "8 Controlling and adjustment functions".</li> </ul>
Nothing indicated in spite of turning on power	<ul style="list-style-type: none"> <li>Scale may possibly be affected by wind or vibration during calibration.</li> </ul>	<ul style="list-style-type: none"> <li>Refer to "Before use" of a separate Operation Manual (Installation) and check how and in what environment the scale is installed.</li> </ul>
Indication flashes	<ul style="list-style-type: none"> <li>Scale may possibly be affected by wind or vibration.</li> </ul>	<ul style="list-style-type: none"> <li>Refer to "Before use" of a separate Operation Manual (Installation) and check how and in what environment the scale is installed.</li> </ul>

## 10-3 Maintenance method

Please maintain the scale referring to the Installation Manual attached to the scale.

# Appendix

---

## Appendix 1 Specification

### Appendix 1-1 Connectable scales

Model name	Max (g)	e (g)	d (g)	Indication limit (g)
FZ623Ex	620	0.01	0.001	620.090
FZ3202Ex	3200	0.1	0.01	3200.90
FZ6202Ex	6200	0.1	0.01	6200.90
FZ15001Ex	15000	1	0.1	15009.0

Model name	Max (g)	e (g)	d (g)	Indication limit (g)
FZ30K0.1GEx	30000	1	0.1	30009.0

Model name	Max (g)	e (g)	d (g)	Indication limit (g)
FZ60K0.1GEx	60000	1	0.1	60009.0
FZ100K1GEx	100000	10	1	100090
FZ200K1GEx	200000	10	1	200090

Model name	Max (g)	e (g)	d (g)	Indication limit (g)
FZ150K1GFEx	150000	10	1	150090
FZ300K1GFEx	300000	10	1	300090

<b>Appendix 1-2      Functional specification</b>
---

Weighing system	Tuning fork vibration type
Protection class	IP65
Type of scale	Weight scale / Percent scale / Coefficient scale
Functions	<p>Adding functions (addition accumulating, net addition, plus side addition, minus side addition)</p> <p>Comparator function (2-point setting, 3-point discrimination, absolute value / relative value discrimination)</p> <p>Buzzer setting, Direct start,</p> <p>Tare weight value storage, Preset tare weight subtraction, Tare weight output,</p> <p>Gross weight indication, Indication unit selection (g / kg), Minimum indication selection</p> <p>Minimum weight indication function, ISO / GLP / GMP functions, Lock function, Span adjustment history</p> <p>Password setting, Auto power-off</p> <p>Storage and calling of device setting information (one item), Storage and calling of user information (100 items)</p>
Indication	<p>Main LCD</p> <p>No backlight, 7-segment, 7 digits max.</p> <p>Segment height: 25 mmh, width: 12.5 mm, slope angle (italic type): 3°</p> <p>Weight indication: 7 digits, Message indication: 7 digits, Bar graph indication: 20 steps</p> <p>Sub LCD (Type i03) only</p> <p>No backlight, 7-segment, 7 digits max.</p> <p>Segment height: 11.7 mmh, width: 5.8 mm, slope angle (italic type): 3°</p> <p>Weight indication: 7 digits, Message indication: 7 digits</p>
Zero, tare weight subtraction	<p>Zero adjustment with [Zero] key (Stability waiting: yes/no selectable)</p> <p>Actual weight subtraction with [Tare] key (Stability waiting: yes/no selectable)</p>
Zero tracking	Provided (Can be disabled via setting)
Overload indication	When indication limit is exceeded, "o-Err" is indicated. (See Appendix 1-1 "Connectable scales".)
Standard output	<p>IR communication (Infrared communication)</p> <p>RS-232C bidirectional output</p>
Span adjustment	Span adjustment by the use of an external weight
Power	Dedicated power supply box
Main unit weight	<p>Indicator section    i02:    Approx. 1.7 kg</p> <p>                                  i03:    Approx. 1.8 kg</p>

Operating temperature / humidity	Temperature: Scale section and Indicator section : +5 °C/ +40 °C Power Supply Box: 0°C to +40 °C Humidity: 85%RH or lower (with no condensation)
Altitude	Not higher than 2000 m above sea level
Overvoltage category	II
Pollution degree	Indicator and scale : 3 Power Supply Box: 2
Option	FJ pole stand FJ table stand Extension DC power supply cable (in 5m units, max. 95m) Glass windshield, size S, M and L Power supply box M

**Appendix 1-3 Dimensional outline drawing**

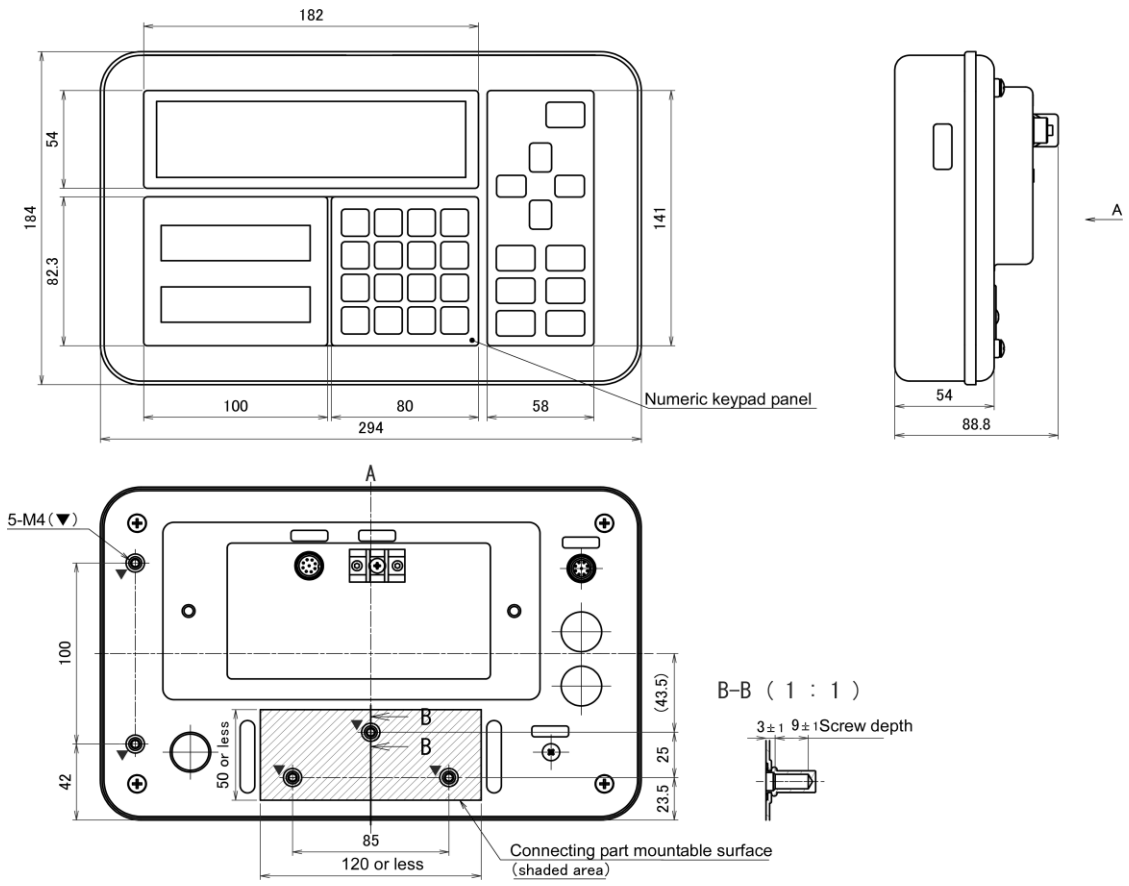

## Appendix 2 Operation of the setting menu

### ■ Setting of various functions

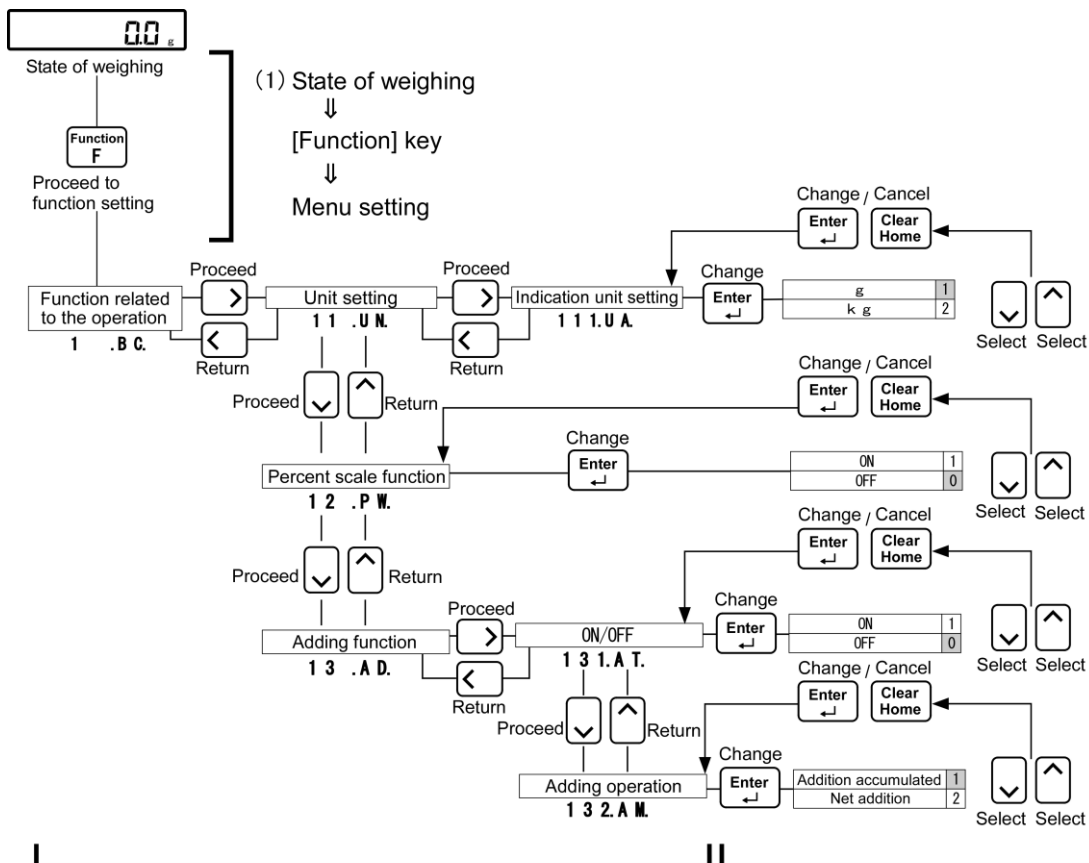

(2) [Direction] key ⇒ Shift to the intended setting item.

(3) [Enter] and [Direction] keys ⇒ Change the setting value.



■ Returns to the state of weighing after completion of setting

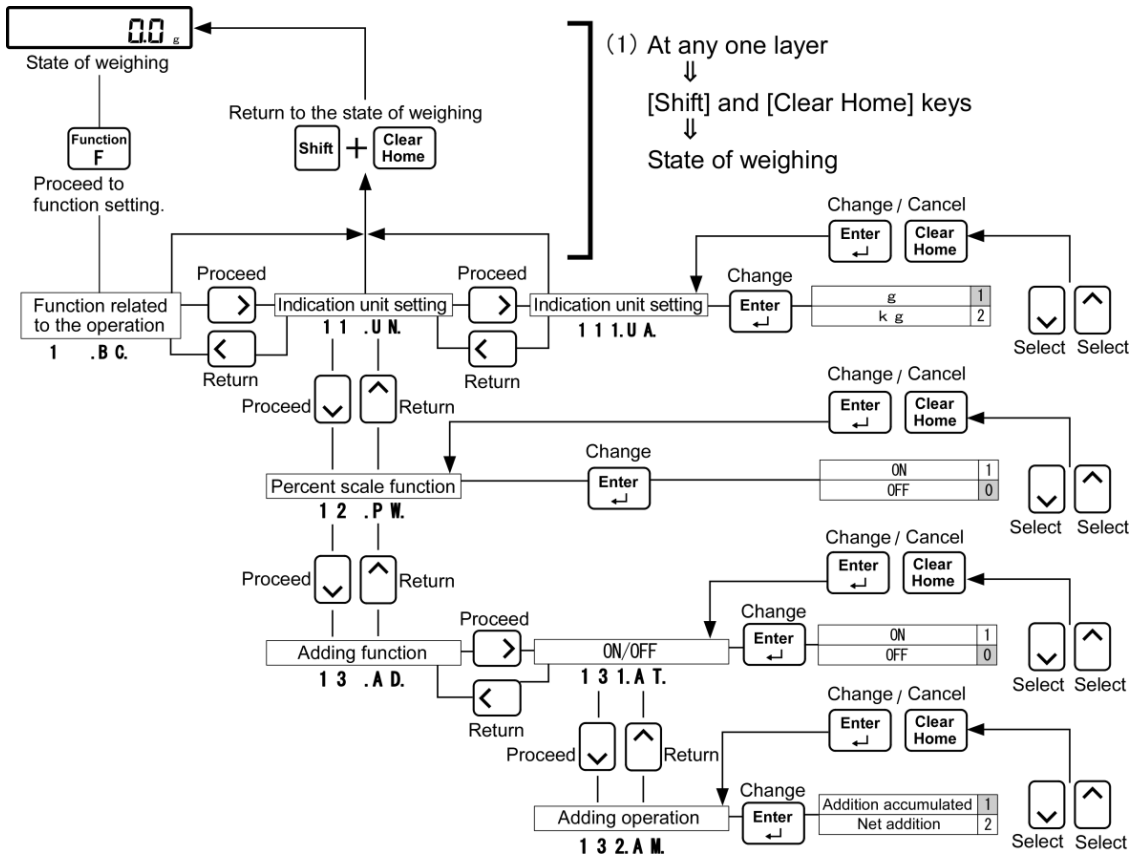

## Appendix 3 Setting menu hierarchy list

### ■ Hierarchy of functions related to the operation

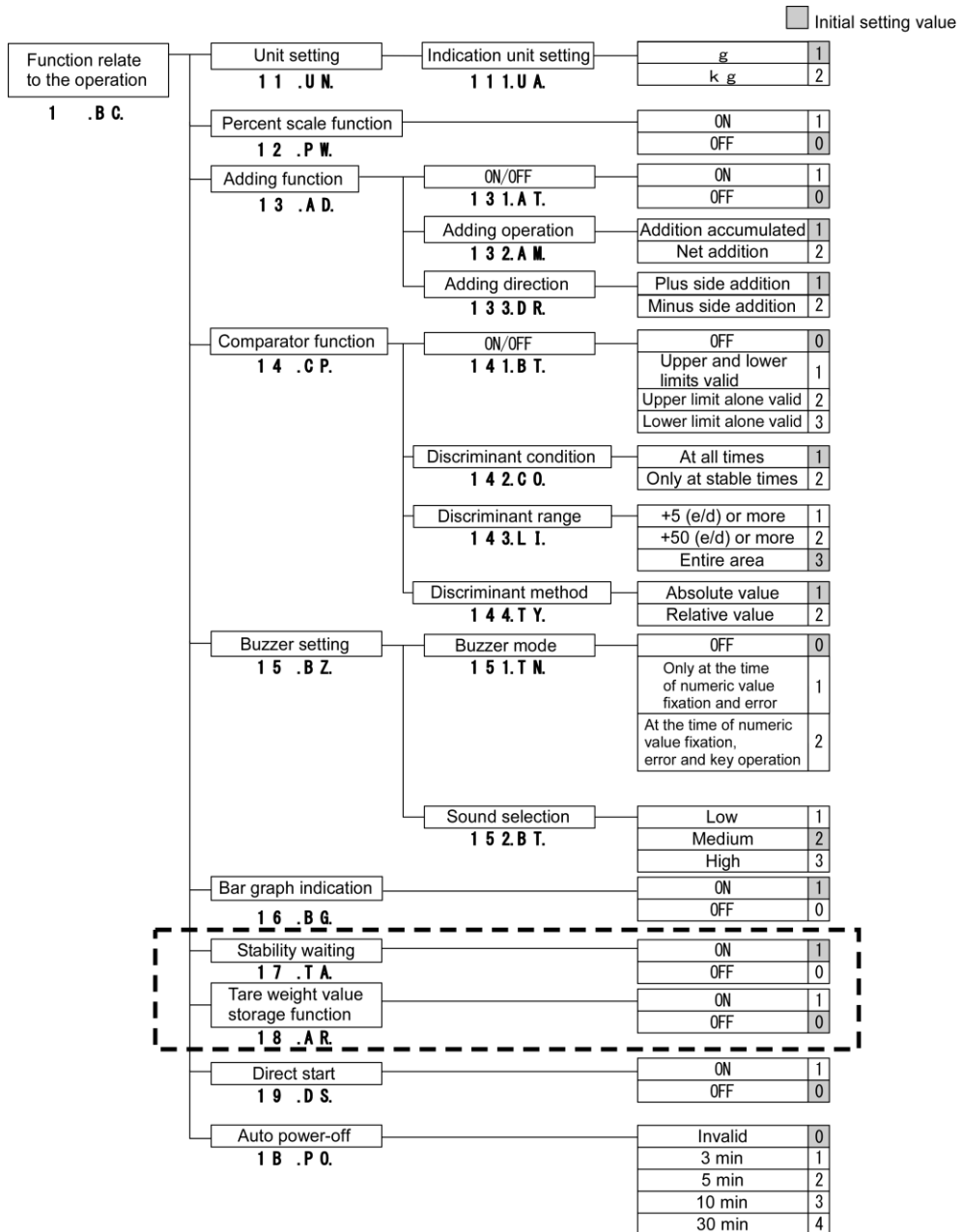

Legal  
Metrology

” [ - - - ] “ can not be used.

■ Hierarchy of functions related to the performance

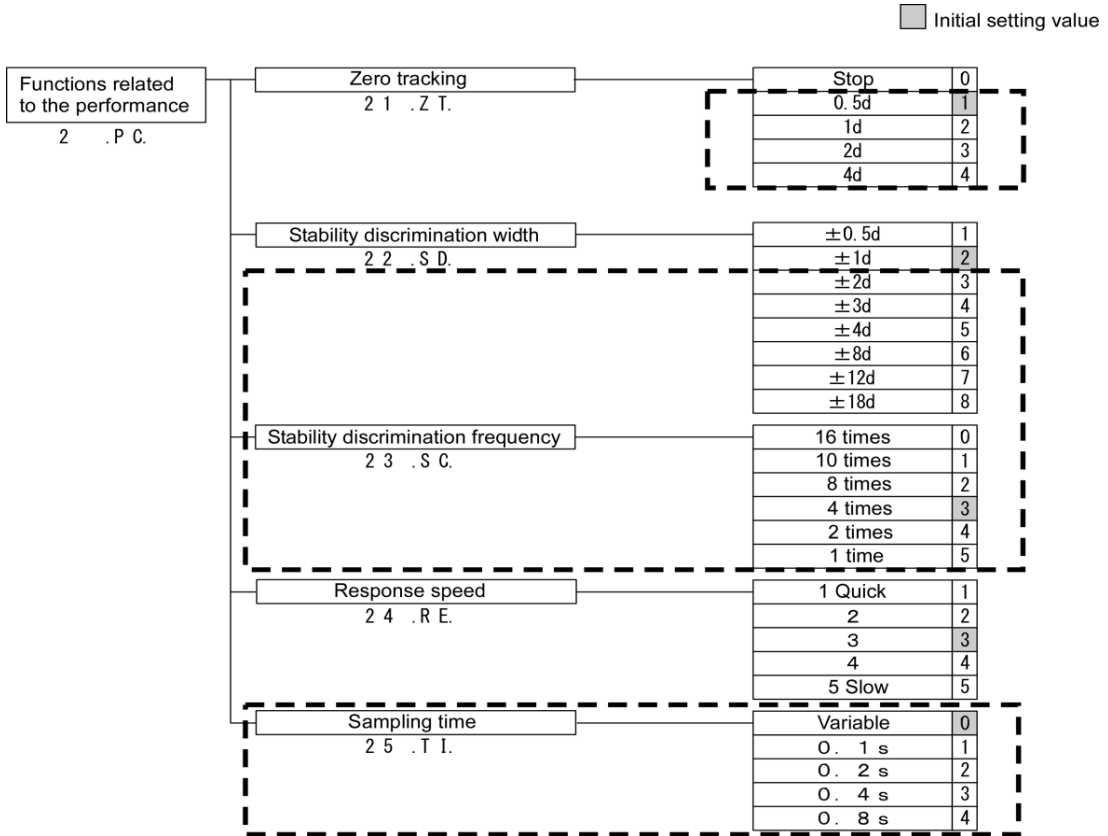

■ Hierarchy of user information setting

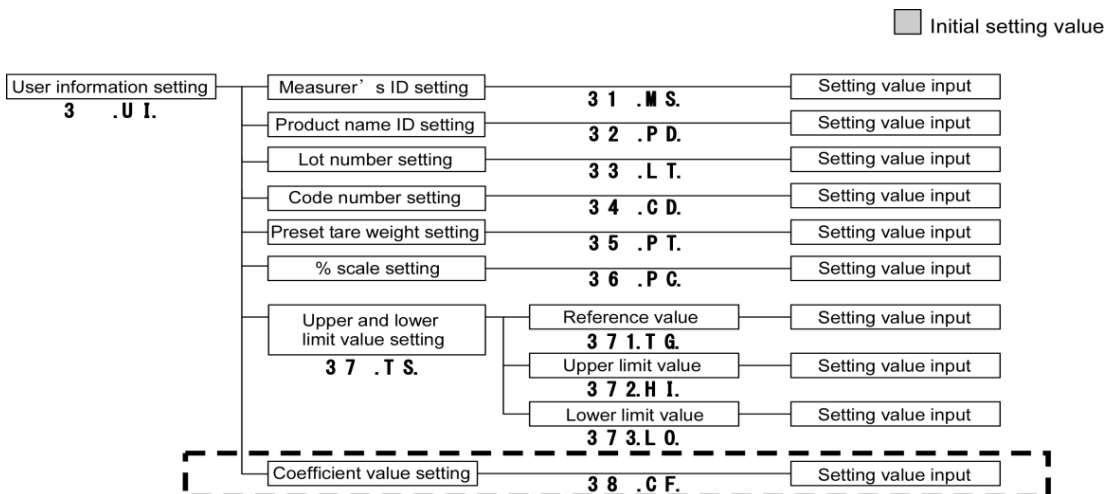

<div style="border: 1px solid black; padding: 2px; display: inline-block;">                 Legal Metrology             </div>	” [dashed box] “ can not be used.
--	-----------------------------------

■ Hierarchy of the external input/output functions

■ Initial setting value

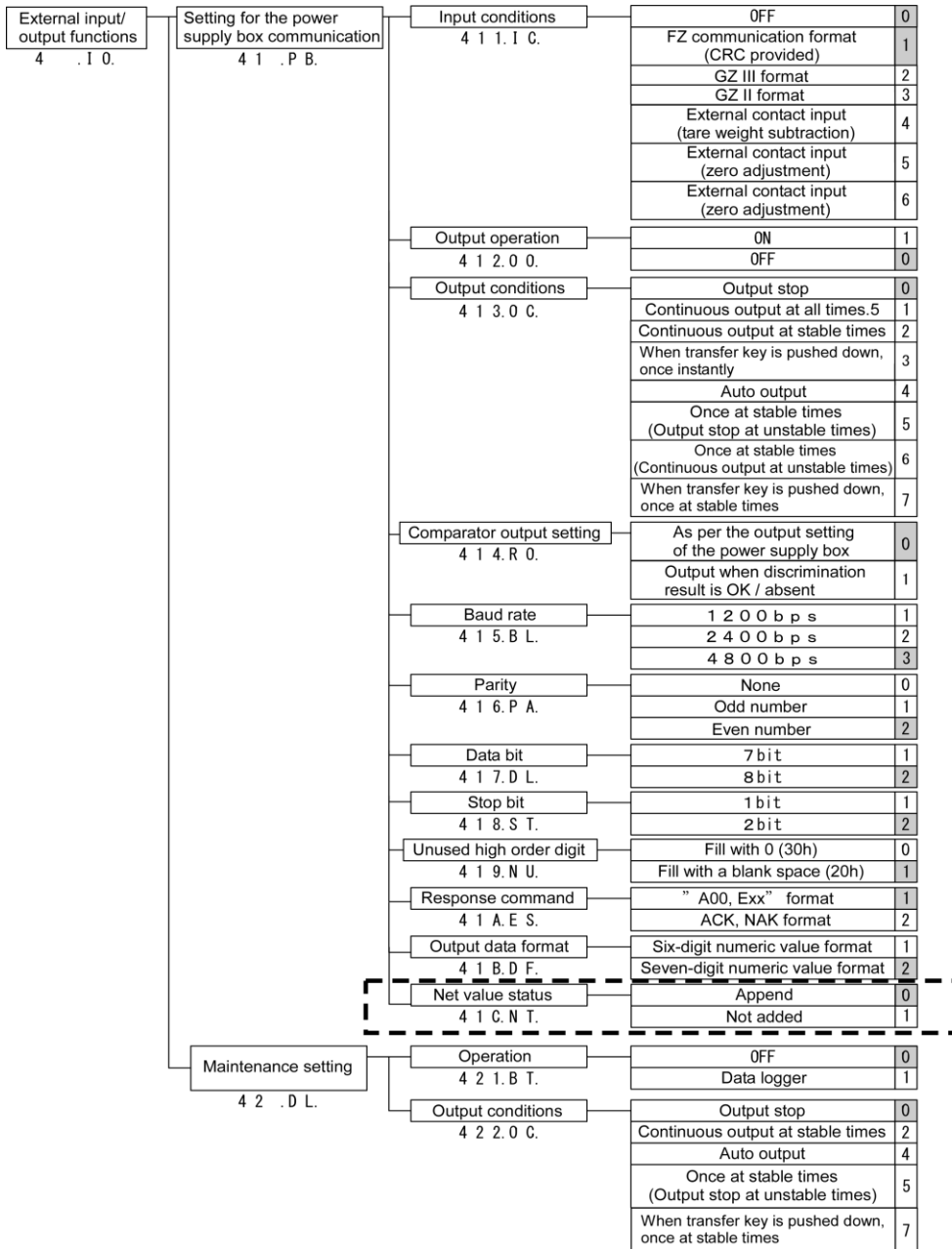

" [ ] " can not be used.

■ Hierarchy of functions related to the lock

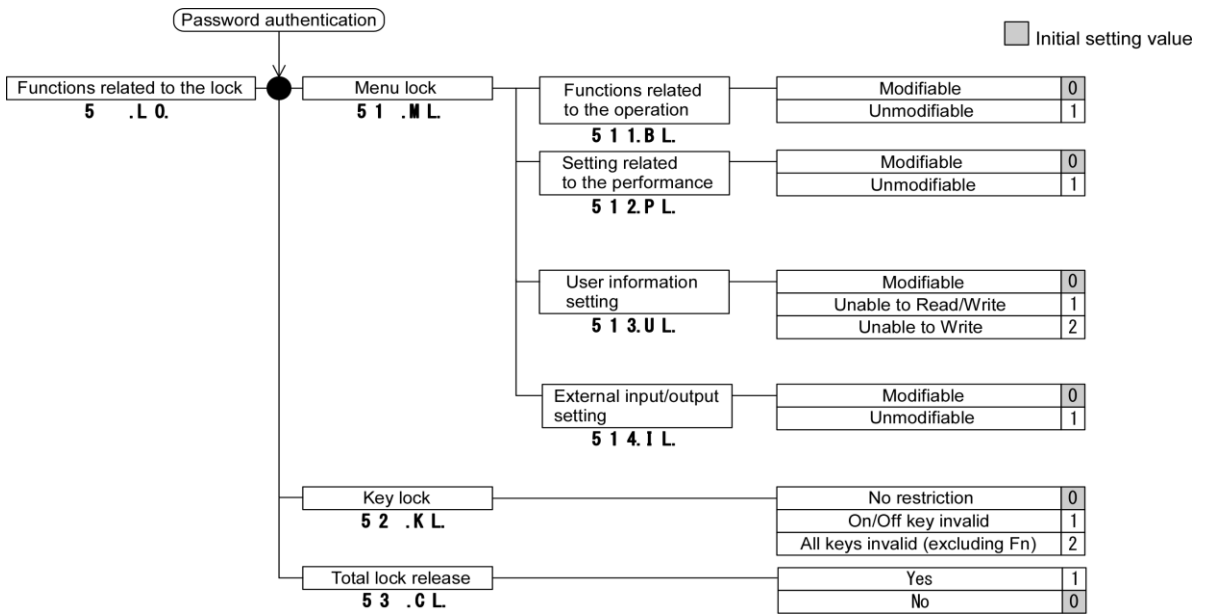

■ Hierarchy of controlling and adjustment functions

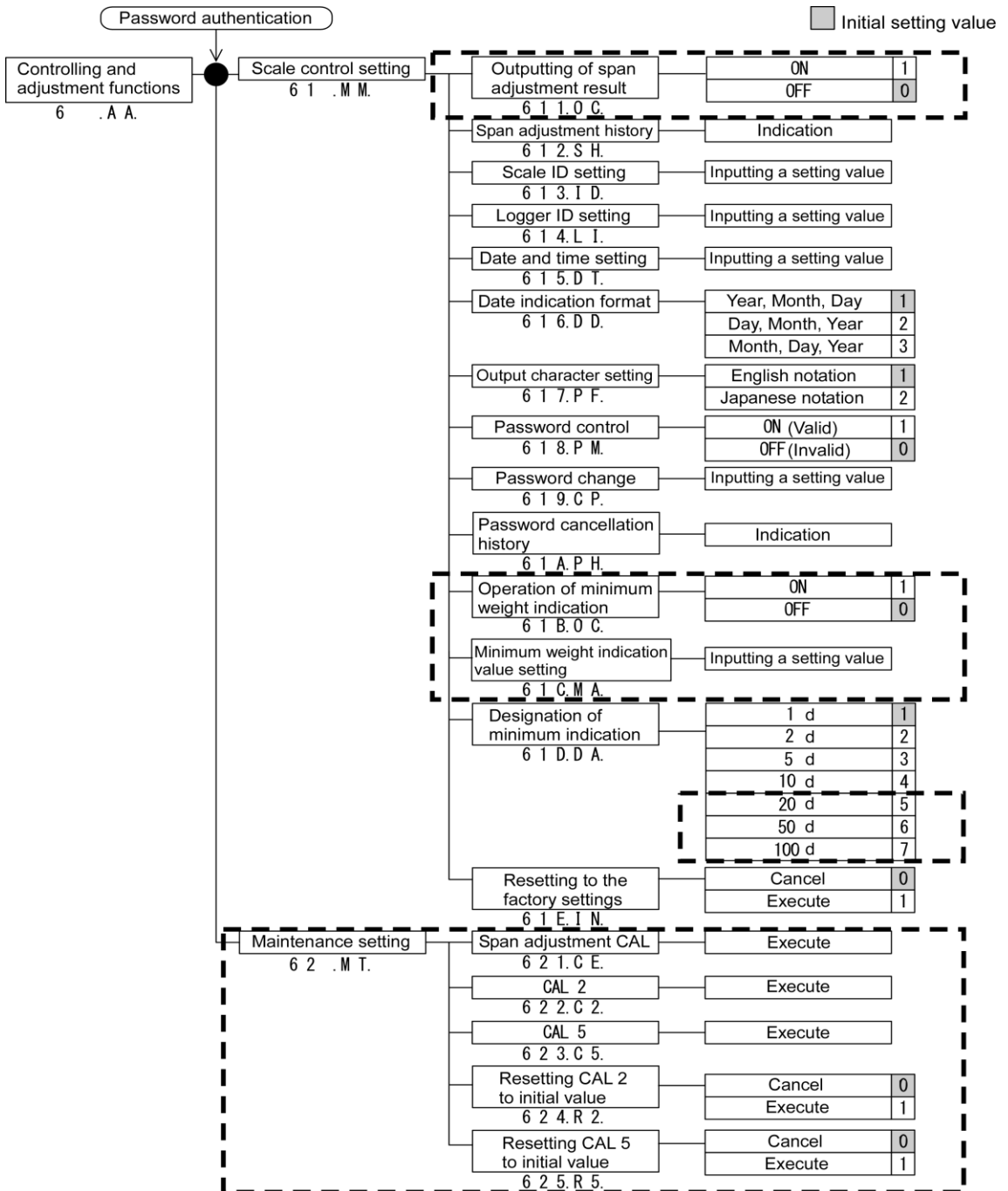

<div style="border: 1px solid black; padding: 2px; display: inline-block;"> <p style="margin: 0;">Legal Metrology</p> </div>	<p>” [dashed box] “ can not be used.</p>
--	--

**Appendix 4      Print sample**

■Span adjustment result

```

**CALIBRATION**

DATE: 2015.06.15
TIME:      14:08
SHINKO DENSHI
TYPE:
      FZ623Ex-i02
S/N:   123456789
ID:    0123456789

CAL. EXTERNAL
REF:
      0.003g

COMPLETE
DATE: 2015.06.15
TIME:      14:08

SIGNATURE

*****
    
```

English

```

***   コウセイ   ***

ヒツケ: 2015.06.15
シコク:      14:08
SHINKO DENSHI
カタシキ:
      FZ623Ex-i02
セイハン 123456789
ID:      0123456789

コウセイ(カイフントウ
キシユン:
      0.003g

シュウリョウ
ヒツケ: 2015.06.15
シコク:      14:08

シヨメイ

*****
    
```

Japanese

■Header

```

SHINKO DENSHI
TYPE :
      FZ623Ex-i02
S/N :   1 2 3 4 5 6 7 8 9
ID :    0 1 2 3 4 5 6 7 8 9
MA :                               none

START
DATE : 2015 . 06 . 15
TIME :           14 : 08
    
```

English

```

SHINKO DENSHI
カタシキ :
      FZ623Ex-i02
セイハン 1 2 3 4 5 6 7 8 9
ID :    0 1 2 3 4 5 6 7 8 9
MA :                               none

カイシ
ヒツケ : 2015 . 06 . 15
シコク :           14 : 08
    
```

Japanese

<div data-bbox="115 919 225 950" data-label="Text"> <p>Reference</p> </div>	<p>“MA” is “Minimum weight indication value setting”, See Chapter 8 Controlling and adjustment functions.</p> <p>When you have not set up “Minimum weight indication value”, it is printed as “none”.</p>
---	---

■Footer

```

END
DATE : 2015 . 06 . 15
TIME :           14 : 08

SIGNATURE

*****
    
```

English

```

シュウリョウ
ヒツケ : 2015 . 06 . 15
シコク :           14 : 08

シヨメイ

*****
    
```

Japanese



# Index of Terms

---

## [A]

Actual value setting method.....	35, 38, 42
Adding function .....	21
Addition accumulated .....	21
Auto power-off.....	28

## [C]

Character font .....	6
Check sum .....	76
Coefficient value setting .....	45

## [D]

Date .....	61
Direct start.....	28

## [E]

Error messages.....	79
Execution menu .....	71

## [F]

Factory settings.....	67
-----------------------	----

## [G]

GLP .....	75
-----------	----

## [I]

Inputting of characters .....	17
Inputting of numeric values .....	16

## [L]

Lock .....	56, 57
------------	--------

## [M]

Main LCD .....	5, 12
Maintenance .....	70
Maintenance setting.....	60
Minimum .....	65
Minimum weighed value .....	78
Minimum weight.....	64

Minus side addition.....	21
--------------------------	----

## [N]

Numeric value setting method.....	35, 36, 38, 39
-----------------------------------	----------------

## [P]

Password.....	62, 63
Plus side addition .....	21
Program number .....	76

## [R]

Response .....	52
Response speed .....	31

## [S]

Scale ID.....	60
Span adjustment.....	67
Stability discrimination frequency .....	31
Stability discrimination width.....	30
Sub LCD.....	12
Sub LCD.....	6

## [T]

Tare .....	10
Tare weight .....	77
Time.....	61

## [U]

Unit setting .....	20
User information .....	72, 73

## [W]

Weight renewal interval .....	32
-------------------------------	----

## [Z]

Zero adjustment range .....	9
Zero tracking .....	30





